



# Krautkrämer ultrasonic transducers

For flaw detection and sizing

# Quality at every step

For 70 years, Krautkrämer ultrasonic transducers have been synonymous with quality.

Our core ability is to match ultrasonic probes to the inspection applications of today, both simple and complex. This skill lets us design and manufacture fine-tuned quality probes that meet your customer-specific requirements.

We build quality into every step we perform—from start to finish:

- **Requirement analysis.** At the very beginning of our discussions with you, we draw on our experience manufacturing more than 1 million probes—including 14,000 probe variations—to build quality into our requirement analysis process.
- **Specifications.** To help ensure quality results, each product in our one-stop-shop adheres to our exacting specifications.
- **Simulation.** Early in the process, we use industry leading simulation technology software to help us determine what needs to be done to meet application requirements. We also understand the boundaries of simulation and how that impacts the build.
- **Feasibility studies.** We support challenging applications by conducting feasibility studies in our labs, which are located worldwide. Send us your samples and we can determine the best inspection method and technology.
- **Material selection and processing.** We use the highest standards when sourcing our raw materials, and our in-house manufacturing is fully controlled to ISO standards. Our ceramics shop in Shannon, Ireland, creates piezocomposite ceramics, an in-house offering unique to our business.
- **Prototyping.** With a strong understanding of your needs, we offer prototyping to further validate that the solution works.
- **Product validation.** With an emphasis on repeatability and process stability, our exacting build-and-test procedures and specifications are followed for every single build, meaning every step includes a quality inspection/test to meet required criteria. What's documented: Each probe has a unique serial number, and every validated manufacturing step is recorded before shipment. Finally, our database stores historical test data for every probe. We provide a certification of conformance, including probe waveform and frequency spectrum results with each probe.
- **Manufacturing.** With manufacturing available in both Europe and the USA, we can provide local variation and meet local norms. In fact, we can customize your transducer to meet your specific ultrasonic testing applications. Modifications can involve transducer case design, connector options, and element size and shape, including non-standard frequencies, sensitivity, bandwidth and focusing.
- **Delivery.** Our pledge is to provide you with exceptional product availability with our global distribution sites and customer care resources, to ensure that order status is communicated until your probe reaches your door.
- **Support.** We have expert resources available to help you with your ultrasonic inspection challenges including field application engineers and remote service technicians who can be reached through phone or email 24/7. Our probes are backed by a standard one year repair or replace warranty as a testament that we stand behind our products.

Krautkrämer ultrasonic transducers from Inspection Technologies deliver consistent readings. Our quality goes beyond standard, our pricing is competitive, and our products are delivered when and where you need them.

**Now that's quality, every step of the way.**



# Contents

## **05 Transducer selection criteria and performance**

General information—contact inspection and immersion methods

Transducer selection criteria—european standards

Transducer selection criteria—north american standards

## **08 Contact transducers**

Straight beam contact transducers, protective face

Straight beam contact transducers, wear resistant

Straight beam contact transducers, delay line

Straight beam contact transducers, dual element

Angle beam transducers—large sizes

Angle beam transducers—small sizes

Angle beam transducers—dual element

## **33 Immersion transducers**

European

North American

## **38 Transducers for specific applications**

Special application transducers

Phased array transducers

## **40 Transducer accessories**

Cables and adapters

Couplants

Calibration blocks

Transducer kits

## **44 Transducer certification**

## **45 Tables and formulas**

# Transducer selection criteria and performance

## General information

The ultrasonic transducers in this catalog are divided into two general categories, Contact and Immersion.

### Transducers for the contact inspection method

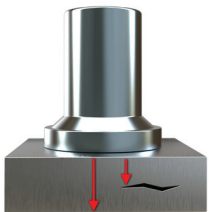

#### Straight beam—single element

- Parts with regular geometry and relatively smooth contact surface
- Flat or curved contact surface
- Flaw or backwall parallel to surface or detectable with beam normal to surface
- Preferred for penetration of thick sections
- Delay line types improve near surface resolution
- Requires couplant layer, typically a gel, oil, or paste
- Typically used for manual inspection

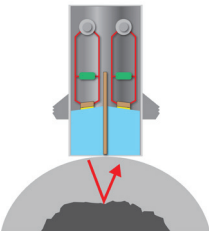

#### Straight beam—dual element (TR)

- Transmit and receive elements separated by crosstalk barrier
- Flaw or backwall parallel to surface or detectable with beam normal to surface
- Best for thin sections, near surface resolution
- Requires couplant layer, typically a gel, oil, or paste
- Typically used for manual inspection

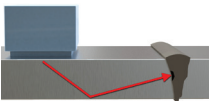

#### Angle beam

- Element mounted on integral or replaceable wedge
- Uses refraction to transmit shear or longitudinal wave at a predetermined angle
- Most standard transducers generate shear waves by mode conversion
- Preferred for parts with inclined flaws, such as welds
- Available in both single and dual element types
- Requires couplant layer, typically a gel, oil, or paste
- Sometimes used in mechanized or automated testing

### Transducers for the immersion method

#### Immersion transducers

- Acoustically matched for best efficiency in water
- Suitable for parts with irregular geometries
- Commonly used in mechanized or automated testing
- Best method for consistent coupling and reproducible results
- Large parts can be tested using probe holders, bubblers, or water jets
- Transducers can be focused to improve results

#### Focused immersion transducers

- Spherical focus forms a point or spot
- Cylindrical focus forms a line

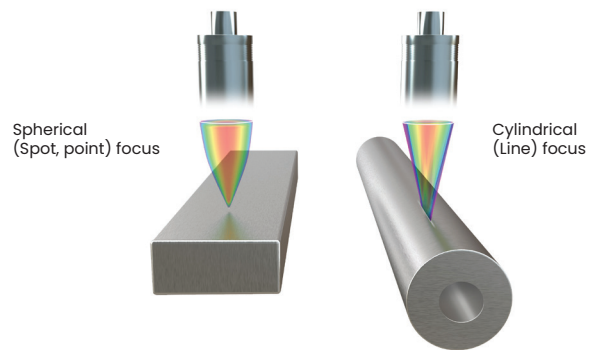

### Advantages of focusing

Increase sensitivity to small flaws

Improve signal-to-noise ratio

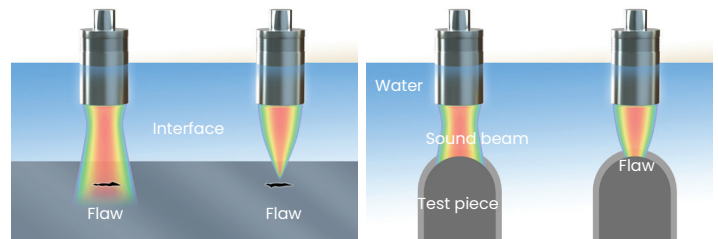
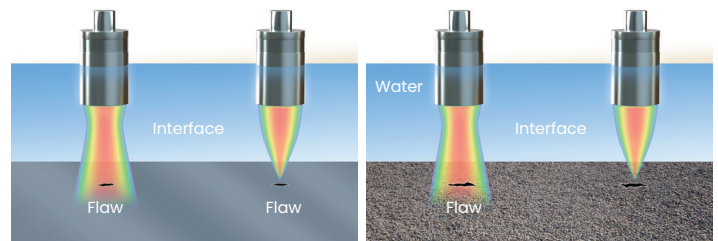

Improve near surface resolution

Correct for contoured surfaces

# Transducer selection criteria— European standards

For transducers manufactured to European standards, technical and performance information is provided throughout this catalog based on the definitions below. A comprehensive data sheet is supplied with most flaw detection transducers at no charge.

Description	Explanation
<b>Element size D or a x b</b>	Diameter D or length x width a x b of the transducer element. The size of the element strongly affects the shape of the transmitted sound field. Slight deviations, (e.g., imperfect shape or positions with reduced radiation due to poor bonding) cause considerable evaluation errors, even when calibrated to a reference flaw.
<b>Nominal frequency f</b>	The mean frequency of all probes of the same type. The frequency has a great influence on the evaluation of reflectors. Even the shape of the sound field and the reflection behaviour of angled reflectors are strongly dependent on the frequency. With increasing frequency, the echo height from non-vertically positioned reflectors to the sound beam decreases. This is why each probe is checked by our Quality Control to see if its frequency coincides with the nominal frequency, according to the identification label, within very narrow tolerances. This is entered into the probe data sheet.
<b>Bandwidth B</b>	<p>The range of frequencies in the echo pulse whose amplitude, at the most, is 6 dB less than the maximum amplitude.</p> $B = \frac{f_o - f_u}{f} \times 100\%$ <p><math>f_o</math> = upper, <math>f_u</math> = lower frequency limit for a 6 dB drop in amplitude.            With B = 100%, a 4 MHz, probe for example, has an <math>f_o</math> of 6 MHz and an <math>f_u</math> of 2 MHz. Large bandwidths mean shorter echo pulses, which mean high resolution and a good penetration power, because the lower frequencies of the pulse become less attenuated than the nominal frequency. At high attenuation, the frequency of reflected signals decreases, compared to the nominal frequency, as the distance increases. This must be taken into account with flaw evaluation. The bandwidth of each probe is therefore checked and must, within narrow tolerances, coincide with the mean value of all probes.</p>
<b>Focal distance F</b>	The distance of a small reflector from the probe producing the highest possible echo. Probes are focused in order to detect small reflectors and produce a high echo amplitude. Focusing is only possible within the near field of the probe.
<b>Near field length N</b>	<p>The near field length N is the focal distance of the unfocused probe which constitutes the sound pressure maximum at the largest distance from the probe. N is determined by D, c and f.</p> $\text{For } D \gg \lambda \text{ is: } N = \frac{D^2_{\text{eff}}}{4\lambda} = \frac{D^2_{\text{eff}} \cdot f}{4c}$ <p><math>\lambda</math> = wave length    <math>c</math> = sound velocity    <math>D_{\text{eff}}</math> = effective element diameter            Focal point and near field length are the distances with the best sound concentration and reflector recognition. Therefore, when a probe is selected for a critical test, the flaw expectancy range must be in the focal area or near field length. The data in the tables refers to steel with the exception of immersion testing in water.</p>
<b>Focal diameter <math>FD_6</math></b>	<p>Diameter of the sound field in the focal distance or near field length with a 6 dB drop of the echo indication.</p> $\text{For } D \gg \lambda \text{ is: } FD_6 = \frac{F \cdot c}{f - D_{\text{eff}}} = \frac{1}{4} \cdot D_{\text{eff}} \cdot k \quad \text{with } k = \frac{F}{N}$
<b>Pulse shape</b>	The presentation of signals, as they are at the instrument input coming from plane reflectors.
<b>Spectrum</b>	Display of all the frequencies in the echo pulse. The frequency amplitudes are shown over the frequency.
<b>Beam angle <math>\beta</math></b>	The angle between the main beam and the normal axis of the test surface.

# Transducer selection criteria— North American standards

For transducers manufactured to North American standards, Baker Hughes Inspection Technologies offers three performance ranges: **Alpha**, **Benchmark**, and **Gamma Series**. Waveform and frequency certification, per ASTM E-1065, are supplied with all flaw detection transducers at no charge.

## Alpha series features

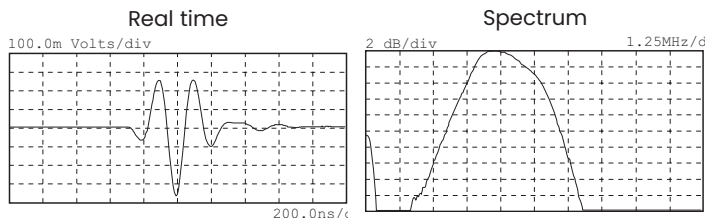

- Recommended for applications where resolution is the primary consideration.
- Suitable for applications such as thickness measurement and near-surface flaw detection.
- Very short pulse—mechanically damped to the limit of current technology.
- Gain is usually lower than that of the Gamma and Benchmark Series.
- Broadband—typical 6 dB bandwidths range from 50% to 100%.
- Typical Alpha waveforms (right) exhibit one to two full ring cycles, depending on frequency, size and other parameters.

## Benchmark series features

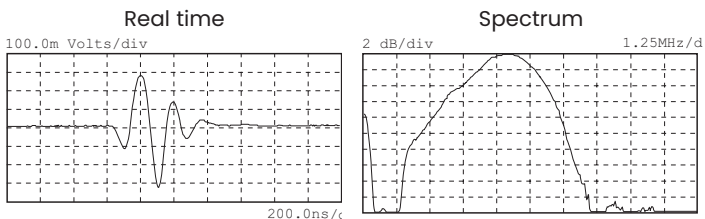

- Proprietary **BENCHMARK COMPOSITE**<sup>®</sup> (piezocomposite) active elements.
- Penetration in attenuative materials is far superior to conventional transducers.
- High signal to noise on coarse grain metals, fiber reinforced composites, et al.
- Short pulse—resolution usually superior to Gamma Series.
- Gain is usually higher than that of the Gamma and Alpha Series.
- Very broadband—typical 6 dB bandwidths range from 60% to 120%.
- Low acoustic impedance element improves performance of angle beam, delay line, and immersion probes—excellent match to plastic and water.

## Gamma series features

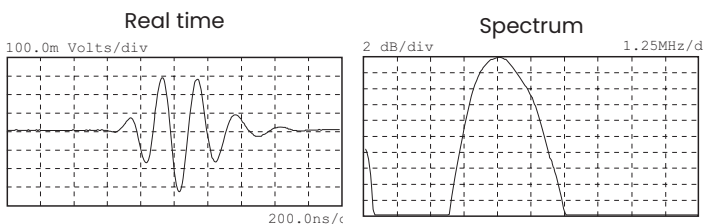

- General purpose transducers, recommended for the majority of applications.
- Medium pulse, medium damping—best combination of gain and resolution.
- Matching electrical network ensures maximum gain and optimum waveform for general use.
- Medium bandwidth—typical 6 dB bandwidths range from 30% to 50%.
- Typical Gamma waveform exhibits three to four full ring cycles, depending on frequency, size and other parameters.

# Contact transducers

## Straight beam contact transducers, protective face



### Applications

- General purpose, larger parts with simple geometry
- Forgings, billets
- Plates, bars, square profiles
- Containers, machine components, shells
- Inspection at high temperature with delay line

### Features and benefits

- European models have replaceable membrane:
  - Improves coupling on uneven or curved surface
  - Extends transducer life.
  - Suitable for DGS flaw sizing method
  - High temperature delay lines also available
  - Lemo 1 (B..S) or Lemo 00 (MB..S) connector, side mount standard, top mount optional
- North American models can be used with three types of protective face:
  - Membrane improves coupling on uneven or curved surface.
  - Wear cap extends transducer life indefinitely when replaced periodically.
  - High temperature delay line enables testing on surfaces up to 400°F (200°C).
  - BNC connector, side or top mount



# Protective face transducers— European standards

## Types B..S and MB..S



B..S



MB..S

### B2S

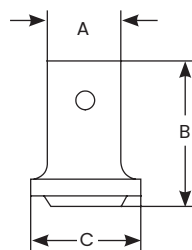
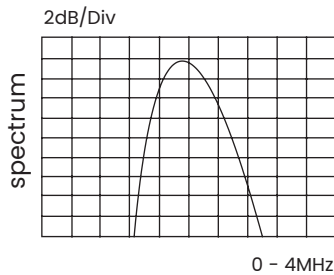
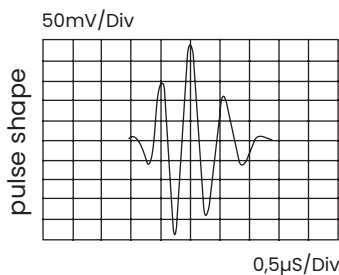

Case type	A		B		C	
	mm	in	mm	in	mm	in
Type 2	30	1.18	59	2.32	45	1.69
Type 3	20	0.79	43	1.77	25	0.98

Typical waveform and frequency spectrum

Type	Order code	D		f (MHz)	N		Notes	Sketch
		mm	in		mm	in		
B 1 S	0057744	24	0.94	1	23	0.9		Type 2
B 1 S-ISO	0500035	24	0.94	1	23	0.9	ISO 22232-2 compliant	
B 1 S-O	0057755	24	0.94	1	23	0.9	Top connector	
B 2 S	0057745	24	0.94	2	45	1.8		
B 2 S-ISO	0500036	24	0.94	2	45	1.8	ISO 22232-2 compliant	
B 2 S-O	0057756	24	0.94	2	45	1.8	Top connector	
B 2 S-O-ISO	0500267	24	0.94	2	45	1.8	ISO 22232-2 compliant, top connector	
B 4 S	0057746	24	0.94	4	88	3.5		
B 4 S-ISO	0500037	24	0.94	4	88	3.5	ISO 22232-2 compliant	
B 4 S-O	0057757	24	0.94	4	88	3.5	Top connector	
B 4 S-O-ISO	0500268	24	0.94	4	88	3.5	ISO 22232-2 compliant, top connector	
B 5 S	0057747	24	0.94	5	110	4.3		
MB 2 S	0057748	10	0.39	2	8	0.3		Type 3
MB 2 S-ISO	0500038	10	0.39	2	8	0.3	ISO 22232-2 compliant	
MB 2 S-O	0057975	10	0.39	2	8	0.3	Top connector	
MB 4 S	0057749	10	0.39	4	16	0.6		
MB 4 S-ISO	0500039	10	0.39	4	16	0.6	ISO 22232-2 compliant	
MB 4 S-O	0057976	10	0.39	4	16	0.6	Top connector	
MB 5 S	0057750	10	0.39	5	20	0.8		
MB 5 S-O	0057977	10	0.39	5	20	0.8	Top connector	

Custom configurations are available by special order.

For explanations to the table data, refer to selection criteria on pages 5 through 7.

## Accessories

Description	Type	Remark
Protective membrane (1 set = 10 pcs)	ES45 (0053756) ES24 (0053769)	for B..S; for MB..S;
Delay line or delay wedges	Special order	e.g., for testing at high temperatures.
Cables	PKLL2 (0050326) MPKL2 (0050486)	for B..S for MB..S

# Protective face transducers— North American standards

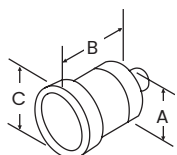

Element Ø		A		B		C	
mm	in	mm	in	mm	in	mm	in
13	0.50	19.1	0.75	30.5	1.20	23.9	0.94
19	0.75	25.4	1.00	30.5	1.20	30.2	1.19
25	1.00	31.8	1.25	30.5	1.20	36.6	1.44

## Protective face combination transducers—type PFCR (side mount BNC), PFCS (top mount BNC)

Freq. (MHz)	Element Ø		Order code		Freq. (MHz)	Element Ø		Order code	
	mm	in	Gamma series PFCR	Gamma series PFCS		mm	in	Gamma series PFCR	Gamma series PFCS
1.0	13	0.50	113-241-240	113-241-260	3.50	13	0.50	113-243-240	113-243-260
	19	0.75	113-251-240	113-251-260		19	0.75	113-253-240	113-253-260
	25	1.00	113-261-240	113-261-260		25	1.00	113-263-240	113-263-260
2.25	13	0.50	113-242-240	113-242-260	5.0	13	0.50	113-244-240	113-244-260
	19	0.75	113-252-240	113-252-260		19	0.75	113-254-240	113-254-260
	25	1.00	113-262-240	113-262-260		25	1.00	113-264-240	113-264-260

Note: Protective face option kits sold separately. Custom configurations are available by special order.

## Protective face option kits—PFCR/PFCS

Kit styles	Order code		
	Transducer element Ø		
	.5 in (13 mm)	.75 in (19 mm)	1.00 in (25 mm)
PM	118-450-120	118-450-140	118-450-160
PWC	118-450-220	118-450-240	118-450-260
PHTD - 1.0 in (25.4 mm) delay	118-450-320	118-450-340	118-450-360
PHTD - 1.5 in (38.1 mm) delay	118-450-420	118-450-440	118-450-460

**Style PM Kit** includes a knurled ring, gland nut, wrench, 12 membranes, and a 2 oz. bottle of couplant (transducer not included).

**Style PWC Kit** includes a knurled ring, three wear caps, and a 2 oz. bottle of couplant (transducer not included). This option may not be usable if near surface resolution is critical.

**Style PHTD Kit** includes a knurled ring, high temperature delay line, and a 2 oz. bottle of couplant (transducer not included).

	Order code		
	Transducer element Ø		
	.5 in (13 mm)	.75 in (19 mm)	1.00 in (25 mm)
Spare membranes pkg. of 12 pcs.	118-220-020	118-220-021	118-220-022
Spare wear caps pkg. of 12 pcs.	118-240-123	118-240-122	118-240-121
Hi-Temp. Delay Line* 1.0 in (25.4 mm) length	118-440-027	118-440-031	118-440-035
Hi-Temp. delay Line* 1.5 in (38.1 mm) length	118-440-029	118-440-033	118-440-037
BNC cable	118-140-016		
Membrane, wear cap and delay line couplant	118-300-740		

\* High temp (PHTD) delay line: maximum temperature 400°F (200°C), maximum contact time 10 seconds; cool to ambient before reuse.

# Straight beam contact transducers, wear resistant



## Applications

- General purpose, metal parts with simple geometry
- Manual inspection of plate, large forgings, billets, castings
- Smaller models for pipe and tube, tanks, bars, small forgings
- Lamination, delamination
- Bond testing
- Thick sections or difficult to penetrate materials

## Features and benefits

- Permanent, abrasion—resistant wear plate
- Best match to metals
- Higher gain reserve than protective face models
- Fingertip models for access to tight spaces
- Comfortable grip
- European models have side mounted Lemo 00 connectors, side mounted Microdot on K..K and G..K types.
- North American models have BNC connectors (side or top mount), side mounted Microdot on F type.

# Wear resistant transducers— European standards

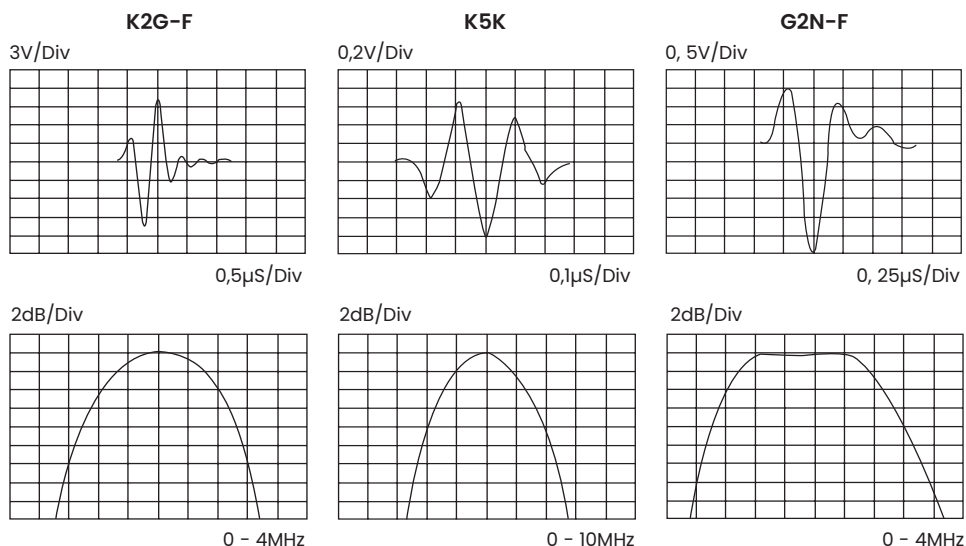

Typical waveform and frequency spectrum

Type	Order code	D		f (MHz)	N		Notes	Sketch
		mm	in		mm	in		
K 1 G	0058506	24	0.94	1	23	0.9	Type 5	
K 2 G	0058507	24	0.94	2	45	1.8		
K 2 G-ISO	0500071	24	0.94	2	45	1.8		ISO 22232-2 compliant
K 4 G	0058508	24	0.94	4	88	3.5		
K 4 G-ISO	0500072	24	0.94	4	88	3.5		ISO 22232-2 compliant
K 1 N	0067620	10	0.39	1	4	0.2	Type 6	
K 2 N	0058509	10	0.39	2	8	0.3		
K 4 N	0058510	10	0.39	4	16	0.6		
K 5 N	0058511	10	0.39	5	20	0.8		
K 5 K	0052831	5	0.20	5	5	0.2	Type 7	
K 5 K-ISO	0500061	5	0.20	5	5	0.2		ISO 22232-2 compliant
K 10 K	0052832	5	0.20	10	10	0.4		
K 10 K-ISO	0500062	5	0.20	10	10	0.4		ISO 22232-2 compliant
G 1 N	0058500	24	0.94	1	23	0.9	Type 5	
G 2 N	0058501	24	0.94	2	45	1.8		
G 4 N	0058502	24	0.94	4	88	3.5		
G 2 KB	0058503	10	0.39	2	8	0.3	Type 6	
G 5 KB	0058504	10	0.39	5	20	0.8		
G 5 K	0053057	5	0.20	5	5	0.2	Type 7	
G 10 K	0053052	5	0.20	10	10	0.4		

Custom configurations are available by special order.

For explanations to the table data, refer to selection criteria on pages 5 through 7.

## Types K..G, K..N, K..K, G..N, G..KB and G..K

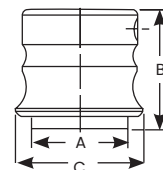

Case type	A		B		C	
	mm	in	mm	in	mm	in
Type 5	30	1.18	37	1.46	40	1.57
Type 6	15	0.59	31	1.22	26	1.02
Type 7	10	0.39	17	0.67		

## Accessories

Description	Type	Remark
Probe cable	MPKL2 (0050486)	for K..G, K..N, G..N, and G..KB
	MPKM2 (0052999)	for K..K and G..K

# Wear resistant transducers— European standards

## Types B..F and MB..F

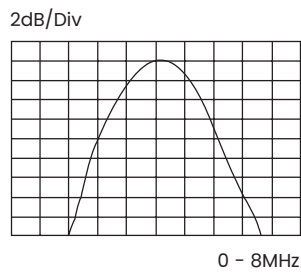
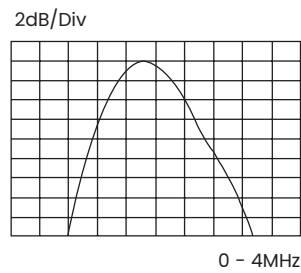
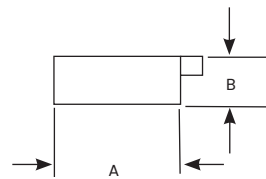
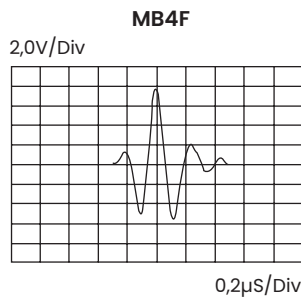
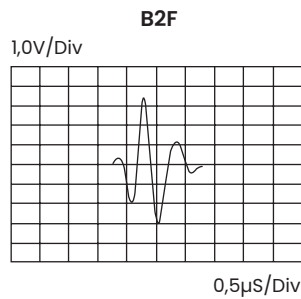
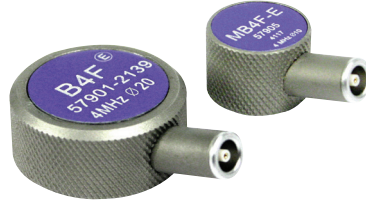

Case type	A		B	
	mm	in	mm	in
Type 8	31	1.22	16	0.63
Type 9	19	0.75	16	0.63

Typical waveform and frequency spectrum

Type	Order code	D		f	N		Notes	Sketch
		mm	in	(MHz)	mm	in		
B 1 F	0057899	20	0.79	1	16	0.6		Type 8
B 2 F	0057900	20	0.79	2	31	1.2		
B 4 F	0057901	20	0.79	4	62	2.4		
B 5 F	0057902	20	0.79	5	76	3.0		
MB 2 F	0057904	10	0.39	2	8	0.3		Type 9
M B 4 F	0057905	10	0.39	4	16	0.6		
M B 4 F-ISO	0500073	10	0.39	4	16	0.6	ISO 22232-2 compliant	
MB 5 F	0057906	10	0.39	5	19	0.8		
MB 10 F	0057903	10	0.39	10	32	1.4		

## Accessories

Description	Type	Remark
Cable	MPKL2 (0050486)	for B..F and MB..F

Custom configurations are available by special order.

For explanations to the table data, refer to selection criteria on pages 5 through 7.

# Wear resistant transducers— North American standards

## Type RHP

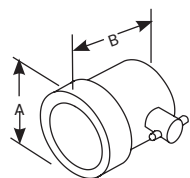

Element Ø		A		B	
mm	in	mm	in	mm	in
13	0.50	29.2	1.15	38.1	1.50
25	0.75	35.6	1.40	38.1	1.50
19	1.00	41.9	1.65	38.1	1.50

## Standard contact transducers—type RHP-CR (side mount BNC), RHP-CS (top mount BNC)

Freq. (MHz)	Element Ø		Order code			Freq. (MHz)	Element Ø		Order code		
	mm	in	Alpha series	Gamma series	Accessories		mm	in	Alpha series	Gamma series	Accessories
0.5	19	0.75		113-250-043-CR 113-250-123-CS	Cables	3.5	13	0.50		113-243-043-CR 113-243-123-CS	Cables
	25	1.00		113-260-043-CR 113-260-123-CS			19	0.75		113-253-043-CR 113-253-123-CS	
1.0	13	0.50		113-241-043-CR 113-241-123-CS	BNC 118-140-016	5.0	13	0.50	113-144-043-CR 113-144-123-CS	113-244-043-CR 113-244-123-CS	BNC 118-140-016
	19	0.75		113-251-043-CR 113-251-123-CS			19	0.75	113-154-043-CR 113-154-123-CS	113-254-043-CR 113-254-123-CS	
2.25	25	1.00		113-261-043-CR 113-261-123-CS	LEMO-1 118-140-018	10.0	25	1.00	113-164-043-CR 113-164-123-CS	113-264-043-CR 113-264-123-CS	
	13	0.50	113-142-043-CR 113-142-123-CS	113-242-043-CR 113-242-123-CS			13	0.50		113-246-043-CR 113-246-123-CS	
	19	0.75	113-152-043-CR 113-152-123-CS	113-252-043-CR 113-252-123-CS							
	25	1.00	113-162-043-CR 113-162-123-CS	113-262-043-CR 113-262-123-CS							

Custom configurations are available by special order.

## Type F

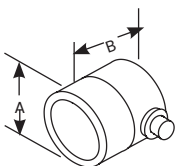

Element Ø		A		B	
mm	in	mm	in	mm	in
6	0.25	12.7	0.50	16.8	0.66
10	0.375	16.0	0.63	16.8	0.66
13	0.50	19.1	0.75	16.8	0.66

## Fingertip contact transducers—type F

Freq. (MHz)	Element Ø		Order code				Freq. (MHz)	Element Ø		Order code			
	mm	in	Benchmark series	Alpha series	Gamma series	Accessories		mm	in	Benchmark series	Alpha series	Gamma series	Accessories
2.25	6	0.250	113-822-000	113-122-000	113-222-000	Cables	5.0	6	0.250	113-824-000	113-124-000	113-224-000	Cables
	10	0.375	113-832-000	113-132-000	113-232-000			10	0.375	113-834-000	113-134-000	113-234-000	
	13	0.500	113-842-000	113-142-000	113-242-000			13	0.500	113-844-000	113-144-000	113-244-000	
3.5	6	0.250		113-123-000	113-223-000	BNC 118-140-012	10.0	6	0.250		113-126-000	113-226-000	BNC 118-140-012
	10	0.375		113-133-000	113-233-000			10	0.375		113-136-000	113-236-000	
	13	0.500		113-143-000	113-243-000			13	0.500		113-146-000	113-246-000	

Custom configurations are available by special order.

# Straight beam contact transducers, delay line



## Applications

- Thickness measurement
- Near surface flaw detection
- Inspection of thin sections
- Curved parts, tubing, pipe
- Composites and plastics
- Turbine blades

## Features and benefits

- Excellent near surface resolution.
- Replaceable delay line—long life and versatility.
- Higher frequencies improve resolution and small flaw detectability.
- All models have side mounted Microdot connector.

# Delay line transducers— European standards

## Type G..MN

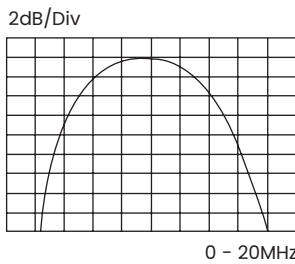
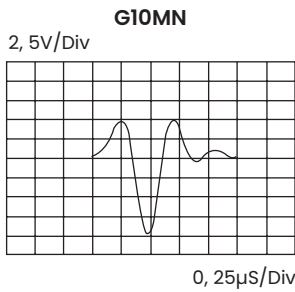
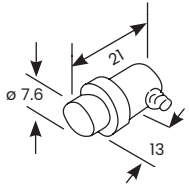

Typical waveform and frequency spectrum

Type	Order code	D mm	D in	f (MHz)	N mm	N in	Sketch
G 5 MN	0053046	5	0.20	5	5	0.2	Type 14
G 10 MN	0053047	5	0.20	10	10	0.4	
G 15 MN	0053058	5	0.20	15	15	0.6	

Custom configurations are available by special order.

## Accessories

Description	Type	Remark
Cable	MPKM2 (0052999)	
Delay Line (exchangeable)	CLFV1 (0054258)	0.37 in (9.5 mm) for G.MN
	CLFV3 (0054262)	0.49 in (12.5 mm) for G.MN



# Delay line transducers— North American standards

## Types DFR and K-PEN

Removable delay line—type DFR

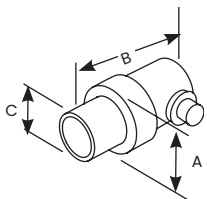

Element Ø		A		B		C	
mm	in	mm	in	mm	in	mm	in
3 or 6	0.125 or 0.25	13	0.51	21.3	0.84	7.6	0.30
13	0.50	22.4	0.88	35.1	1.38	15.2	0.60
Mini-DFR							
3	0.125	10.41	0.41	19.6	0.77	4.8	0.19

## K-PEN replaceable delay line pencil probe

- Focused, high resolution pencil probe
- Interchangeable delay lines, two tip diameters
- Extremely small contact area
- Tightly curved surfaces, such as turbine blades
- Wall thickness measurement from the bottom of an external pit
- Straight, right angle and 45° handles
- Straight model has removable handle

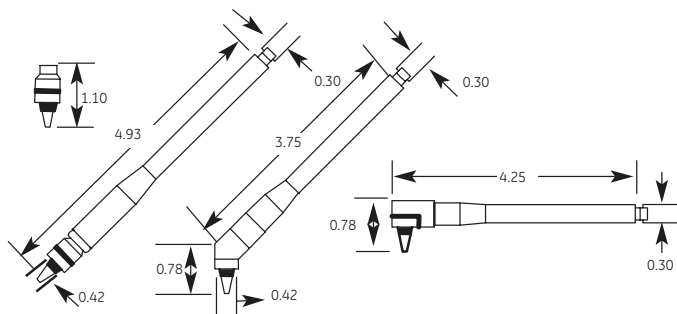

Freq. (MHz)	Order code					
	Straight K-PEN	45° K-PEN	Right angle K-PEN	.065 in (1.7 mm) Tip delay 10-PK	.090 in (2.3 mm) Tip delay 10-PK	BNC cable
7.5	389-042-200	389-042-880	389-042-870	387-003-109	387-003-110	118-140-012
20.0	389-030-290	389-041-270	389-040-660			



Freq. (MHz)	Element Ø		Alpha series	Order code		Accessories
	mm	in		Delay line 10-PK .38 in (9.5 mm) Lg	Delay line 10-PK .5 in (12.7 mm) Lg	
2.25	6	0.250	113-122-660	118-440-050	118-440-051	Cables BNC 118-140-012
	13	0.500	291-140-500		118-440-052	
3.5	6	0.250	113-123-660	118-440-050	118-440-051	LEMO-1 118-140-022
	13	0.500	113-144-660		118-440-052	
5.0	6	0.250	113-124-660	118-440-050	118-440-051	Delay line couplant 118-300-740
	13	0.500	113-140-602		118-440-052	
10.0	6	0.250	113-126-660	118-440-050	118-440-051	Spring loaded VEE block 118-480-007
13	0.500	113-140-602			118-440-052	
15.0	6	0.250	113-127-660	118-440-050	118-440-051	
22.0	3	0.125	113-118-660	118-440-050	118-440-051	
Mini-DFR 20.0	3	0.125	113-518-650	118-440-502		

\*118-480-007 fits .125 in (3 mm) and .25 in (6 mm) units only with exception of Mini DFR. Custom configurations are available by special order.



# Straight-beam contact transducers, dual element



## Applications

- Remaining wall thickness, corrosion, erosion
- Near surface flaw detection
- Small parts—screws, bolts, pins
- Cladding and weld overlay
- Bond testing
- Railroad wheels
- Core flaws in shafts, bars, billets
- Coarse grain materials

## Features and benefits

- Excellent near surface resolution
- Improved coupling on curved and rough surfaces
- Reduce noise caused by scattering
- Can be contoured for curved parts
- European models have side mounted Lemo 00 connectors, side mounted Microdot SEB..KF types
- North American models have fixed BNC cable (ADP) or side mounted MMD (FDU)

# Dual element contact transducers— European standards

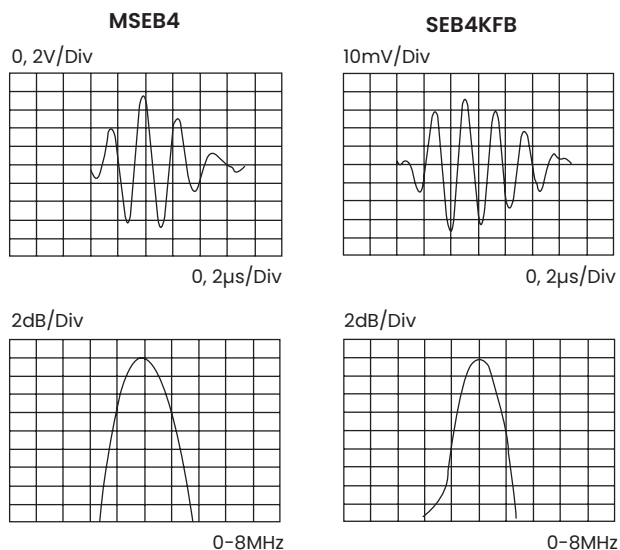

Typical waveform and frequency spectrum

## Types SEB and MSEB



## Types 15 and 16

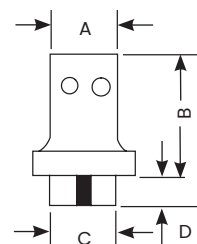

## Types 17 and 18

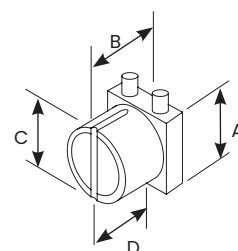

Case type	A		B		C		D	
	mm	in	mm	in	mm	in	mm	in
Type 15	30	1.18	65	2.56	28.5	1.12	10	0.39
Type 16	20	0.79	45	1.77	16.5	0.65	5	0.20
Type 17	14	0.55	17	0.67	13	0.51	6.4	0.25
Type 18	14	0.55	17	0.67	7.5	0.30	6.4	0.25

## Accessories

Description	Type	Remark
Cable	SEKG2 (53887)	for SEB., MSEB.,
	SEKM2 (53001)	for SEB..KF

Type	Order code	a x b		f (MHz)	F		Notes	Sketch
		mm	in		mm	in		
SEB 1	0057466	21 / 2 ø	0.83	1	20	0.8		Type 15
SEB 1-ISO	0500176	21 / 2 ø	0.83	1	20	0.8	ISO 22232-2 compliant	
SEB 2	0057467	7 x 18	.28 x .71	2	15	0.6		
SEB 2-ISO	0500063	7 x 18	.28 x .71	2	15	0.6	ISO 22232-2 compliant	
SEB 2-0°	0057468	7 x 18	.28 x .71	2	30	1.2	Elements at 0° included angle	
SEB 2-EN-0°	0500065	7 x 18	.28 x .71	2	30	1.2	Elements at 0° included angle ISO 22232-2 compliant	
SEB 4	0057469	6 x 20	.24 x .79	4	12	0.5		
SEB 4-ISO	0500064	6 x 20	.24 x .79	4	12	0.5	ISO 22232-2 compliant	
SEB 4-0°	0057470	6 x 20	.24 x .79	4	25	1.0	Elements at 0° included angle	
SEB 4-ISO-0°	0500066	6 x 20	.24 x .79	4	25	1.0	Elements at 0° included angle ISO 22232-2 compliant	
MSEB 2	0057461	11 / 2 ø	0.43	2	8	0.3		Type 16
MSEB 2-ISO	0500067	11 / 2 ø	0.43	2	8	0.3	ISO 22232-2 compliant	
MSEB 4	0057462	3.5 x 10	.14 x .39	4	10	0.4		
MSEB 4-ISO	0500068	3.5 x 10	.14 x .39	4	10	0.4	ISO 22232-2 compliant	
MSEB 4-0°	0057463	3.5 x 10	.14 x .39	4	18	0.7	Elements at 0° included angle	
MSEB 5	0057464	9 / 2 ø	0.35	5	10	0.4	Typical bandwidth 100%	
SEB 2 KF5	0056464	8 / 2 ø	0.31	2	6	0.24		Type 17
SEB 4 KF8	0056465	8 / 2 ø	0.31	4	6	0.24		
SEB 4 KF8-ISO	0500069	8 / 2 ø	0.31	4	6	0.24	ISO 22232-2 compliant	
SEB 5 KF3	0056466	8 / 2 ø	0.31	5	3	0.12		Type 18
SEB10 KF3	0056867	5 / 2 ø	0.20	10	3	0.12		
SEB10 KF3-ISO	0500070	5 / 2 ø	0.20	10	3	0.12	ISO 22232-2 compliant	

Custom configurations are available by special order.

For explanations to the table data, refer to selection criteria on pages 5 through 7.

# Dual element contact transducers— North American standards

## Types ADP and FDU

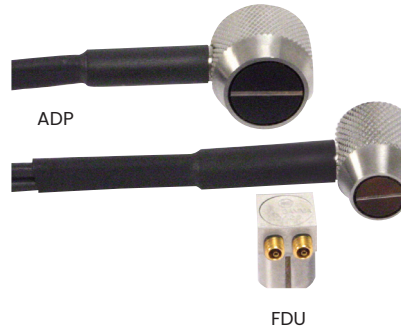
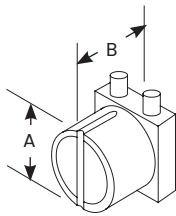
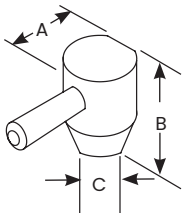

### ADP

Element Ø		A		B		C	
mm	in	mm	in	mm	in	mm	in
6	0.25	12.7	0.50	16.3	0.64	9.1	0.36
10	0.375	16.0	0.63	16.3	0.64	11.9	0.47
13	0.50	19.1	0.75	17.3	0.68	15.2	0.60

### FDU

Element Ø		A		B	
mm	in	mm	in	mm	in
6	0.25	9.7	0.38	12.7	0.50
10	0.375	12.7	0.50	12.7	0.50

## Dual element transducers—types ADP and FDU

Freq. (MHz)	Element Ø		Order code		Freq. (MHz)	Element Ø		Order code	
	mm	in	ADP dual	FDU Dual†		mm	in	ADP dual	FDU dual†
2.25	6	0.250	113-222-700	113-222-680	5.0	6	0.250	113-224-700	113-224-680
	10	0.375	113-232-700	113-232-680		10	0.375	113-234-700	113-234-680
	13	0.500	113-242-700			13	0.500	113-244-700	
3.5	6	0.250	113-223-700	113-223-680	7.5	8	0.300	113-135-700	
	10	0.375	113-233-700	113-233-680		10.0	6	0.250	389-002-771
	13	0.500	113-243-700		13		0.500	389-021-830	

† Standard MMD to BNC dual cable (118-140-014) sold separately. Custom configurations are available by special order.

# Angle beam transducers— large sizes



## Applications

- General weld inspection, larger objects, thicker sections
- Pipes, tanks, pressure vessels
- Axles, forgings, castings
- Bridges and other structures
- Railroad wheels and rail

## Features and Benefits

- European models have integral wedge
  - Maximum precision and repeatability for DGS flaw sizing method
  - Durable, ergonomically designed die cast housing
  - Replacement soles (sold separately) for extended service life
  - Lemo 1 connector on WB and WK types, side mount standard, top mount optional
  - Lemo 00 connector on SWB and SWK types, side mount
- North American models have interchangeable wedges (sold separately)
  - Maximum versatility and service life
  - Custom wedge angles and curvatures can be special ordered
  - AWS models available for AWS Structural Welding Code D1.1
  - High temperature wedges available for testing to 200°C (400°F)
  - BNC connector, top mount

# Large angle beam transducers— European standards

## Types WB/WK and SWB/SWK

Types WB/WK and SWB/SWK

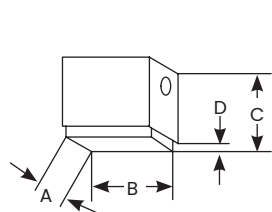

WB45-2

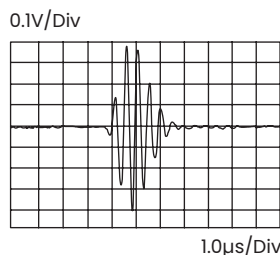

WK60-2

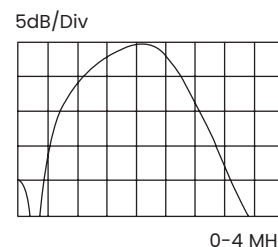
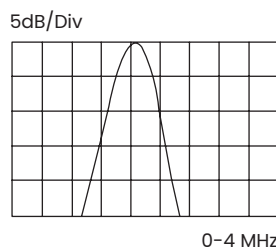
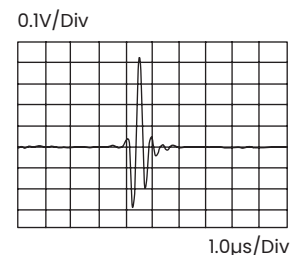

Typical waveform and frequency spectrum

Case type	A		B		C		D	
	mm	in	mm	in	mm	in	mm	in
Type 20	21.5	0.85	37	1.46	31	1.22	3	0.12
Type 21	29	1.14	53.5	2.11	45	1.77	5	0.20

Type	Order code	a x b		f (MHz)	β (Steel)	N		Notes	Sketch
		mm	in			mm	in		
WB 45-1	0056993	20 x 22	0.79 x 0.87	1	45	45	1.8		Type 21
WB 45-1-ISO	0500207	20 x 22	0.79 x 0.87	1	45	45	1.8	ISO 22232-2 compliant	
WB 45-O1	0057217	20 x 22	0.79 x 0.87	1	45	45	1.8	Top connector	
WB 60-1	0056994	20 x 22	0.79 x 0.87	1	60	45	1.8		
WB 60-1-ISO	0500208	20 x 22	0.79 x 0.87	1	60	45	1.8	ISO 22232-2 compliant	
WB 60-O1	0057218	20 x 22	0.79 x 0.87	1	60	45	1.8	Top connector	
WB 70-1	0056995	20 x 22	0.79 x 0.87	1	70	45	1.8		
WB 70-1-ISO	0500209	20 x 22	0.79 x 0.87	1	70	45	1.8	ISO 22232-2 compliant	
WB 70-O1	0057219	20 x 22	0.79 x 0.87	1	70	45	1.8	Top connector	
WB 35-2	0056998	20 x 22	0.79 x 0.87	2	38	90	3.5		
WB 35-2-ISO	0500054	20 x 22	0.79 x 0.87	2	38	90	3.5	ISO 22232-2 compliant	
WB 35-O2	0057222	20 x 22	0.79 x 0.87	2	38	90	3.5	Top connector	
WB 35-O2ISO	0500058	20 x 22	0.79 x 0.87	2	38	90	3.5	ISO 22232-2 compliant	
WB 45-2	0056999	20 x 22	0.79 x 0.87	2	45	90	3.5		
WB 45-2-ISO	0500055	20 x 22	0.79 x 0.87	2	45	90	3.5	ISO 22232-2 compliant	
WB 45-O2	0057223	20 x 22	0.79 x 0.87	2	45	90	3.5	Top connector	
WB 45-O2ISO	0500059	20 x 22	0.79 x 0.87	2	45	90	3.5	ISO 22232-2 compliant	
WB 60-2	0057000	20 x 22	0.79 x 0.87	2	60	90	3.5		
WB 60-2-ISO	0500056	20 x 22	0.79 x 0.87	2	60	90	3.5	ISO 22232-2 compliant	
WB 60-O2	0057224	20 x 22	0.79 x 0.87	2	60	90	3.5	Top connector	
WB 60-O2ISO	0500060	20 x 22	0.79 x 0.87	2	60	90	3.5	ISO 22232-2 compliant	
WB 70-2	0057001	20 x 22	0.79 x 0.87	2	70	90	3.5		
WB 70-2-ISO	0500057	20 x 22	0.79 x 0.87	2	70	90	3.5	ISO 22232-2 compliant	
WB 70-O2	0057225	20 x 22	0.79 x 0.87	2	70	90	3.5	Top connector	
WB 70-O2ISO	0500280	20 x 22	0.79 x 0.87	2	70	90	3.5	ISO 22232-2 compliant	
WB 80-2	0057002	20 x 22	0.79 x 0.87	2	77	90	3.5		
WB 80-2-ISO	0500278	20 x 22	0.79 x 0.87	2	77	90	3.5	ISO 22232-2 compliant	
WB 80-O2	0057226	20 x 22	0.79 x 0.87	2	77	90	3.5	Top connector	
WB 90-2	0057003	20 x 22	0.79 x 0.87	2	90	90	3.5		
WB 90-2-ISO	0500266	20 x 22	0.79 x 0.87	2	90	90	3.5	ISO 22232-2 compliant	
WB 90-O2	0057227	20 x 22	0.79 x 0.87	2	90	90	3.5	Top connector	

# Large angle beam transducers— European standards

Type	Order code	a x b		f (MHz)	β (Steel)	N		Notes	Sketch
		mm	in			mm	in		
WB 35-4	0057004	20 x 22	0.79 x 0.87	4	38	180	7.1		Type 21
WB 35-O4	0057228	20 x 22	0.79 x 0.87	4	38	180	7.1	Top connector	
WB 45-4	0057005	20 x 22	0.79 x 0.87	4	45	180	7.1		
WB 45-4-ISO	0500200	20 x 22	0.79 x 0.87	4	45	180	7.1	ISO 22232-2 compliant	
WB 45-O4	0057229	20 x 22	0.79 x 0.87	4	45	180	7.1	Top connector	
WB 60-4	0057006	20 x 22	0.79 x 0.87	4	60	180	7.1		
WB 60-4-ISO	0500201	20 x 22	0.79 x 0.87	4	60	180	7.1	ISO 22232-2 compliant	
WB 60-O4	0057230	20 x 22	0.79 x 0.87	4	60	180	7.1	Top connector	
WB 70-4	0057007	20 x 22	0.79 x 0.87	4	70	180	7.1		
WB 70-4-ISO	0500202	20 x 22	0.79 x 0.87	4	70	180	7.1	ISO 22232-2 compliant	
WB 70-O4	0057231	20 x 22	0.79 x 0.87	4	70	180	7.1	Top connector	
WB 80-4	0057008	20 x 22	0.79 x 0.87	4	77	180	7.1		
WB 80-O4	0057232	20 x 22	0.79 x 0.87	4	77	180	7.1	Top connector	
<b>Separator</b>									
SWB 45-2	0058414	14 x 14	0.55 x 0.55	2	45	39	1.5		Type 20
SWB 60-2	0058415	14 x 14	0.55 x 0.55	2	60	39	1.5		
SWB 70-2	0058416	14 x 14	0.55 x 0.55	2	70	39	1.5		
SWB 45-5	0058420	14 x 14	0.55 x 0.55	5	45	98	3.9		Type 20
SWB 60-5	0058421	14 x 14	0.55 x 0.55	5	60	98	3.9		
SWB 70-5	0058422	14 x 14	0.55 x 0.55	5	70	98	3.9		
WK 45-1	0067889	20 x 22	0.79 x 0.87	1	45	45	1.8		Piezocomposite element Type 21
WK 60-1	0067890	20 x 22	0.79 x 0.87	1	60	45	1.8		
WK 70-1	0067891	20 x 22	0.79 x 0.87	1	70	45	1.8		
WK 45-2	0057011	20 x 22	0.79 x 0.87	2	45	90	3.5		
WK 60-2	0057012	20 x 22	0.79 x 0.87	2	60	90	3.5		
WK 70-2	0057013	20 x 22	0.79 x 0.87	2	70	90	3.5		
<b>Separator</b>									
SWK 45-2	0058843	14 x 14	0.55 x 0.55	2	45	39	1.5		Piezocomposite element Type 20
SWK 60-2	0058844	14 x 14	0.55 x 0.55	2	60	39	1.5		
SWK 70-2	0058845	14 x 14	0.55 x 0.55	2	70	39	1.5		

Custom configurations are available by special order.

For explanations to the table data, refer to selection criteria on pages 5 through 7.

## Accessories

Description	Type	Remark
Cable	PKL2 (0050326)	for WB., WK..
	MPKL2 (0050486)	for SWB., SWK..
Spare sole (1 set = 10 pcs)	WP(E) (0057276)	for WB., WK..
	SWP (0058514)	for SWB., SWK

# Large angle beam transducers— North American standards

## Types SWS and AWS

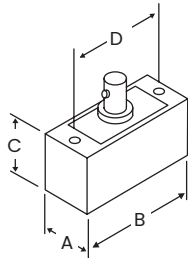

Element size		A		B		C		D	
mm	in	mm	in	mm	in	mm	in	mm	in
13 Ø	.50 Ø	18.3	0.72	25.4	1.00	19.1	0.75	20.6	0.81
13 x 25	.50 x 1.0	18.5	0.725	38.4	1.51	19.1	0.75	33.3	1.31
19 x 25	.75 x 1.0	25.4	1.00	38.1	1.5	19.1	0.75	33.3	1.31
25 Ø	1.0	31.0	1.22	41.9	1.65	19.1	0.75	35.1	1.38
16 x 16	.63 x .63	18.5	0.73	31.8	1.25	19.1	0.75	25.4	1.00
16 x 19	.63 x .75	18.5	0.73	31.8	1.25	19.1	0.75	25.4	1.00
19 x 19	.75 x .75	21.6	0.85	31.8	1.25	19.1	0.75	25.4	1.00

## Angle beam transducers—types SWS and AWS

Freq. (MHz)	Element Ø		Order Code						Freq. (MHz)	Element Ø		Order Code					
			Gamma series	Benchmark series	Standard wedge (W = 118-340)	Hi-Temp wedge* (W = 118-340)	Accessories	Gamma series				Benchmark series	Standard wedge (W = 118-340)	Hi-Temp wedge* (W = 118-340)	Accessories		
0.50	25	1.0	113-260-600		W-021 45°	W-081 45°		16 x 0.63	x	113-292-603	113-892-603	W-104 45°					
					W-022 60°	W-082 60°						W-105 60°					
	13	0.5	113-241-600	113-841-600	W-009 45°	W-076 45°		16 x 0.63	x	113-292-601	113-892-601	W-104 45°					
					W-010 60°	W-077 60°						W-105 60°					
	13 x 25	0.5 x 1	113-291-600	113-891-600	W-011 70°	W-078 70°		19 x 0.75	x	113-292-604	113-892-604	W-104 45°					
					W-015 45°	W-070 45°						W-105 60°					
1.0	19 x 25	0.75 x 1	113-291-605	113-891-605	W-016 60°	W-086 60°		13	0.5	113-243-600	113-843-600	W-106 70°					
					W-017 70°	W-071 70°						W-009 45°					
	25	1.0	113-261-600	113-861-600	W-018 90°	W-088 90°		13 x 25	0.5 x 1	113-293-600	113-893-600	W-010 60°					
					W-021 45°	W-081 45°						W-011 70°					
	13	0.5	113-242-600	113-842-600	W-022 60°	W-082 60°		19 x 25	0.75 x 1	113-293-605	113-893-605	W-016 60°					
					W-023 70°	W-083 70°						W-017 70°					
	13 x 25	0.5 x 1	113-292-600	113-892-600	W-024 90°	W-084 90°		25	1.0	113-263-600	113-863-600	W-018 90°					
					W-025 90°	W-083 70°						W-021 45°					
2.25	19 x 25	0.75 x 1	113-292-605	113-892-605	W-026 45°	W-085 45°		13	0.5	113-244-600	113-844-600	W-081 45°					
					W-027 60°	W-086 60°						W-022 60°					
	25	1.0	113-262-600	113-862-600	W-028 70°	W-087 70°		19 x 25	0.75 x 1	113-294-600	113-894-600	W-023 70°					
					W-029 90°	W-088 90°						W-024 90°					
	19 x 25	0.75 x 1	113-292-605	113-892-605	W-030 45°	W-089 45°		25	1.0	113-264-600	113-864-600	W-025 90°					
					W-031 60°	W-090 60°						W-026 45°					
	25	1.0	113-262-600	113-862-600	W-032 70°	W-091 70°		19 x 25	0.75 x 1	113-294-605	113-894-605	W-027 60°					
					W-033 90°	W-092 90°						W-028 70°					

\* Duty cycle: at 400°F (200°C), maximum contact time is 10 seconds; cool to ambient before reuse. Note: Standard wedge angles are specified for carbon steel. Custom configurations are available by special order.



# Angle beam transducers— small sizes



## Applications

- General weld inspection, smaller objects, thinner sections
- Tubes, pipes, pressure vessels, containers
- Pumps, valve housings
- Turbine blades, shafts
- Wheel rims

## Features and benefits

- European models have integral wedge
  - Maximum precision and repeatability for DGS flaw sizing method
  - Durable, ergonomically-designed die cast housing
  - Replacement soles (sold separately) for extended service life
  - Lemo 00 connector on MWB and MWK types, side mount standard, top mount optional
- North American models have interchangeable wedges (sold separately)
  - Maximum versatility and service life
  - Custom wedge angles and curvatures can be special ordered
  - Both quick change and screw mounted styles available
  - Microdot connector on MSW-QC and MSWS types, MMD on SMSWS

# Small angle beam transducers— European standards

## Type MWB/MWK

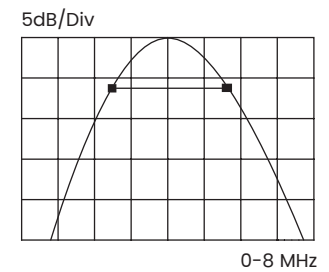
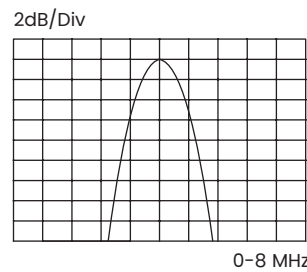
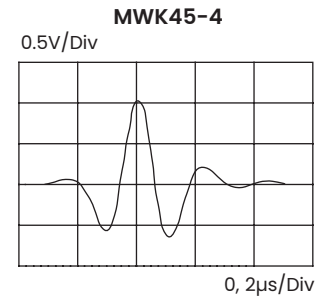
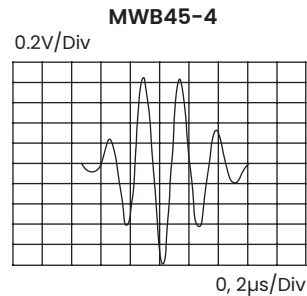
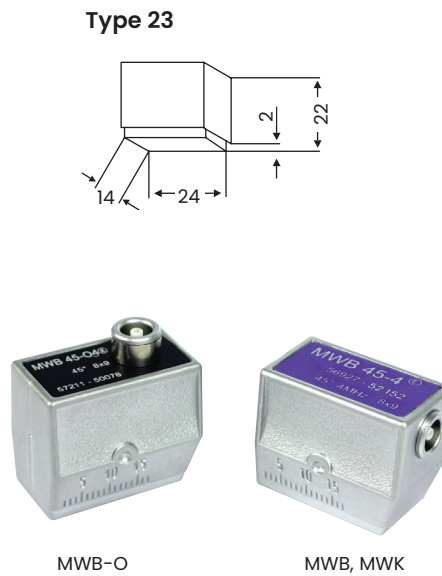

Typical waveform and frequency spectrum

Type	Order code	a x b mm	in	f (MHz)	β (Steel)	N mm	in	Notes	Sketch
MWB 35-2	0056920	8 x 9	0.31 x 0.35	2	38	15	0.6		Type 23
MWB 35-2ISO	0500040	8 x 9	0.31 x 0.35	2	38	15	0.6	ISO 22232-2 compliant	
MWB 35-O2	0057204	8 x 9	0.31 x 0.35	2	38	15	0.6	Top connector	
MWB 35-O2ISO	0500044	8 x 9	0.31 x 0.35	2	38	15	0.6	ISO 22232-2 compliant	
MWB 45-2	0056921	8 x 9	0.31 x 0.35	2	45	15	0.6		
MWB 45-2ISO	0500041	8 x 9	0.31 x 0.35	2	45	15	0.6	ISO 22232-2 compliant	
MWB 45-O2	0057205	8 x 9	0.31 x 0.35	2	45	15	0.6	Top connector	
MWB 45-O2ISO	0500045	8 x 9	0.31 x 0.35	2	45	15	0.6	ISO 22232-2 compliant	
MWB 60-2	0056922	8 x 9	0.31 x 0.35	2	60	15	0.6		
MWB 60-2ISO	0500042	8 x 9	0.31 x 0.35	2	60	15	0.6	ISO 22232-2 compliant	
MWB 60-O2	0057206	8 x 9	0.31 x 0.35	2	60	15	0.6	Top connector	
MWB 60-O2ISO	0500046	8 x 9	0.31 x 0.35	2	60	15	0.6	ISO 22232-2 compliant	
MWB 70-2	0056923	8 x 9	0.31 x 0.35	2	70	15	0.6		
MWB 70-2ISO	0500043	8 x 9	0.31 x 0.35	2	70	15	0.6	ISO 22232-2 compliant	
MWB 70-O2	0057207	8 x 9	0.31 x 0.35	2	70	15	0.6	Top connector	
MWB 70-O2ISO	0500234	8 x 9	0.31 x 0.35	2	70	15	0.6	ISO 22232-2 compliant	
MWB 80-2	0056924	8 x 9	0.31 x 0.35	2	77	15	0.6		
MWB 80-O2	0057208	8 x 9	0.31 x 0.35	2	77	15	0.6	Top connector	
MWB 90-2	0056925	8 x 9	0.31 x 0.35	2	90	15	0.6	Surface wave	

# Small angle beam transducers— European standards

Type	Order code	a x b		f (MHz)	β (Steel)	N		Notes	Sketch	
		mm	in			mm	in			
MWB 35-4	0056926	8 x 9	0.31 x 0.35	4	38	30	1.2		Type 23	
MWB 35-4ISO	0500047	8 x 9	0.31 x 0.35	4	38	30	1.2	ISO 22232-2 compliant		
MWB 35-O4	0057210	8 x 9	0.31 x 0.35	4	38	30	1.2	Top connector		
MWB 35-O4ISO	0500235	8 x 9	0.31 x 0.35	4	38	30	1.2	ISO 22232-2 compliant		
MWB 45-4	0056927	8 x 9	0.31 x 0.35	4	45	30	1.2			
MWB 45-4ISO	0500048	8 x 9	0.31 x 0.35	4	45	30	1.2	ISO 22232-2 compliant		
MWB 45-O4	0057211	8 x 9	0.31 x 0.35	4	45	30	1.2	Top connector		
MWB 45-O4ISO	0500236	8 x 9	0.31 x 0.35	4	45	30	1.2	ISO 22232-2 compliant		
MWB 60-4	0056928	8 x 9	0.31 x 0.35	4	60	30	1.2			
MWB 60-4ISO	0500049	8 x 9	0.31 x 0.35	4	60	30	1.2	ISO 22232-2 compliant		
MWB 60-O4	0057212	8 x 9	0.31 x 0.35	4	60	30	1.2	Top connector		
MWB 60-O4ISO	0500237	8 x 9	0.31 x 0.35	4	60	30	1.2	ISO 22232-2 compliant		
MWB 70-4	0056929	8 x 9	0.31 x 0.35	4	70	30	1.2			
MWB 70-4ISO	0500050	8 x 9	0.31 x 0.35	4	70	30	1.2	ISO 22232-2 compliant		
MWB 70-O4	0057213	8 x 9	0.31 x 0.35	4	70	30	1.2	Top connector		
MWB 70-O4ISO	0500238	8 x 9	0.31 x 0.35	4	70	30	1.2	ISO 22232-2 compliant		
MWB 80-4	0056930	8 x 9	0.31 x 0.35	4	7	30	1.2			
MWB 80-O4	0057214	8 x 9	0.31 x 0.35	4	77	30	1.2	Top connector		
MWB 90-4	0056931	8 x 9	0.31 x 0.35	4	90	30	1.2	Surface wave		
MWK 45-2	0067488	8 x 9	0.31 x 0.35	2	45	15	0.6		Piezocomposite element	
MWK 60-2	0067489	8 x 9	0.31 x 0.35	2	60	15	0.6			
MWK 70-2	0067490	8 x 9	0.31 x 0.35	2	70	15	0.6			
MWK 45-4	0058938	8 x 9	0.31 x 0.35	4	45	30	1.2			
MWK 60-4	0058939	8 x 9	0.31 x 0.35	4	60	30	1.2			
MWK 70-4	0058940	8 x 9	0.31 x 0.35	4	70	30	1.2			

Custom configurations are available by special order.

For explanations to the table data, refer to selection criteria on pages 5 through 7.

## Accessories

Description	Type	Remark
Cable	MPKL2 (0050486)	for MWB., MWK..
Spare sole (1 set = 10 pcs)	MWP(E) (0057277)	for MWB., MWK..

# Small angle beam transducers— North American standards

## Type MSWS

Replaceable wedge .25 in (6 mm)												
Wedge angle	A		B		C		D		E		F	
	mm	in	mm	in	mm	in	mm	in	mm	in	mm	in
45°	11.9	0.47	15.2	0.60	7.6	0.30	7.9	.31	12.2	0.48	8.6	0.34
60°	11.9	0.47	16.5	0.65	8.9	0.35	7.9	.31	12.2	0.48	8.6	0.34
70°	11.9	0.47	17.8	0.70	9.7	0.38	7.9	.31	12.2	0.48	8.6	0.34
90°	11.9	0.47	22.9	0.90	9.7	0.38	7.9	.31	12.2	0.48	8.6	0.34

Replaceable wedge .50 in (13 mm)												
Wedge angle	A		B		C		D		E		F	
	mm	in	mm	in	mm	in	mm	in	mm	in	mm	in
45°	18.5	0.73	24.4	0.96	10.7	0.42	14.2	0.56	18.5	0.73	12.7	0.50
60°	18.5	0.73	27.4	1.08	12.7	0.50	14.2	0.56	18.5	0.73	12.7	0.50
70°	18.5	0.73	29.5	1.16	13.7	0.54	14.2	0.56	18.5	0.73	12.7	0.50
90°	18.5	0.73	39.6	1.56	14.7	0.58	14.2	0.56	18.5	0.73	12.7	0.50

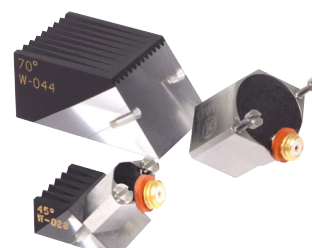
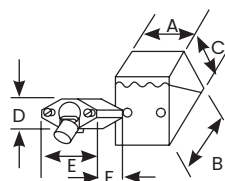

## Miniature angle beam transducers—type MSWS (Captive screw mount)

Freq. (MHz)	Element Ø		Order code			Freq. (MHz)	Element Ø		Order code		
	mm	in	Gamma series	Standard wedge	Accessories		mm	in	Gamma series	Standard wedge	Accessories
1.0	13	0.500	113-241-580	118-340-040	45°	6	0.250	113-224-580	118-340-028	45°	Cables BNC 118-140-012
				118-340-042	60°				118-340-030	60°	
				118-340-044	70°				118-340-032	70°	
				118-340-046	80°				118-340-034	80°	
				118-340-048	90°				118-340-036	90°	
2.25	6	0.250	113-222-580	118-340-028	45°	13	0.500	113-244-580	118-340-040	45°	Cables BNC 118-140-012 LEMO-1 118-140-022
				118-340-030	60°				118-340-042	60°	
				118-340-032	70°				118-340-044	70°	
				118-340-034	80°				118-340-046	80°	
				118-340-036	90°				118-340-048	90°	
3.5	13	0.500	113-242-580	118-340-040	45°	6	0.250	113-226-580	118-340-028	45°	Wedge couplant 118-300-740
				118-340-042	60°				118-340-030	60°	
				118-340-044	70°				118-340-032	70°	
				118-340-046	80°				118-340-034	80°	
				118-340-048	90°				118-340-036	90°	
3.5	6	0.250	113-223-580	118-340-028	45°	13	0.500	113-246-580	118-340-040	45°	
				118-340-030	60°				118-340-042	60°	
				118-340-032	70°				118-340-044	70°	
				118-340-034	80°				118-340-046	80°	
				118-340-036	90°				118-340-048	90°	
3.5	13	0.500	113-243-580	118-340-040	45°	6	0.250	113-246-580	118-340-040	45°	
				118-340-042	60°				118-340-042	60°	
				118-340-044	70°				118-340-044	70°	
				118-340-046	80°				118-340-046	80°	
				118-340-048	90°				118-340-048	90°	

Note: Standard wedge angles are specified for carbon steel. Custom configurations are available by special order.

## Type MSW-QC

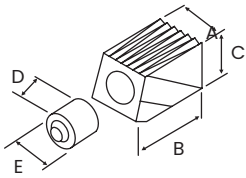

Replaceable wedge 6 mm (.25 in)											
Wedge angle	A		B		C		D		E		Thread
	mm	in	mm	in	mm	in	mm	in	mm	in	in
45°	11.4	0.45	19.1	0.75	9.4	0.37	14.1	0.56	10.7	0.42	3/8 - 32
60°	11.4	0.45	21.3	0.84	11.2	0.44	14.1	0.56	10.7	0.42	3/8 - 32
70°	11.4	0.45	25.4	1.00	12.7	0.50	14.1	0.56	10.7	0.42	3/8 - 32
90°	11.4	0.45	24.1	0.95	12.7	0.50	14.1	0.56	10.7	0.42	3/8 - 32

Replaceable wedge 10 mm (.375 in)											
Wedge angle	A		B		C		D		E		Thread
	mm	in	mm	in	mm	in	mm	in	mm	in	in
45°	14.0	0.55	22.6	0.89	11.9	0.47	14.7	0.58	14.0	0.55	1/2 - 28
60°	14.0	0.55	26.4	1.04	14.0	0.55	14.7	0.58	14.0	0.55	1/2 - 28
70°	14.0	0.55	30.2	1.19	14.7	0.58	14.7	0.58	14.0	0.55	1/2 - 28
90°	14.0	0.55	29.2	1.15	15.5	0.61	14.7	0.58	14.0	0.55	1/2 - 28

Replaceable wedge 13 mm (.50 in)											
Wedge angle	A		B		C		D		E		Thread
	mm	in	mm	in	mm	in	mm	in	mm	in	in
45°	17.8	0.70	26.7	1.05	14.0	0.55	16.5	0.65	17.8	0.70	5/8 - 24
60°	17.8	0.70	31.5	1.24	16.3	0.64	16.5	0.65	17.8	0.70	5/8 - 24
70°	17.8	0.70	35.8	1.41	17.3	0.68	16.5	0.65	17.8	0.70	5/8 - 24
90°	17.8	0.70	35.3	1.39	18.5	0.73	16.5	0.65	17.8	0.70	5/8 - 24

## Miniature angle beam transducers—type MSW-QC (Quick change)

Freq. (MHz)	Element Ø		Order code						Freq. (MHz)	Element Ø		Order code																			
			Gamma series	Benchmark series	Alpha series	Standard wedge	Accessories	Gamma series				Benchmark series	Alpha series	Standard wedge	Accessories																
1.0	13	0.500	113-241-590	113-241-591			118-340-210 30°		6	0.250	113-224-590	113-224-591	113-124-591	118-340-200 30°				118-340-201 45°				118-340-202 60°				118-340-203 70°				118-340-204 90°	
							118-340-220 30°							118-340-220 30°																	
							118-340-221 45°							118-340-221 45°																	
							118-340-222 60°							118-340-222 60°																	
							118-340-223 70°							118-340-223 70°																	
118-340-224 90°	118-340-224 90°																														
1.5	10	0.375	113-231-590	113-231-596			118-340-210 30°		5.0	10	0.375	113-234-590	113-234-591	113-134-591	118-340-210 30°				118-340-211 45°				118-340-212 60°				118-340-213 70°				118-340-214 90°
							118-340-220 30°								118-340-220 30°																
							118-340-221 45°								118-340-221 45°																
							118-340-222 60°								118-340-222 60°																
							118-340-223 70°								118-340-223 70°																
118-340-224 90°	118-340-224 90°																														
2.25	6	0.250	113-222-590	113-222-591	113-122-591		118-340-200 30°		7.5	10	0.375	113-235-591	113-135-591	118-340-200 30°				118-340-201 45°				118-340-202 60°				118-340-203 70°				118-340-204 90°	
							118-340-220 30°							118-340-220 30°																	
							118-340-221 45°							118-340-221 45°																	
							118-340-222 60°							118-340-222 60°																	
							118-340-223 70°							118-340-223 70°																	
118-340-224 90°	118-340-224 90°																														
3.5	10	0.375	113-233-590	113-233-591	113-133-591		118-340-210 30°		10	10	0.375	113-236-590		118-340-210 30°				118-340-211 45°				118-340-212 60°				118-340-213 70°				118-340-214 90°	
							118-340-220 30°							118-340-220 30°																	
							118-340-221 45°							118-340-221 45°																	
							118-340-222 60°							118-340-222 60°																	
							118-340-223 70°							118-340-223 70°																	
118-340-224 90°	118-340-224 90°																														
3.5	13	0.500	113-243-590	113-243-591	113-143-591		118-340-210 30°		10	13	0.500	113-246-590		118-340-210 30°				118-340-211 45°				118-340-212 60°				118-340-213 70°				118-340-214 90°	
							118-340-220 30°							118-340-220 30°																	
							118-340-221 45°							118-340-221 45°																	
							118-340-222 60°							118-340-222 60°																	
							118-340-223 70°							118-340-223 70°																	
118-340-224 90°	118-340-224 90°																														

# Small angle beam transducers— North American standards

Angle	A		B		C		D		E		F	
	mm	in	mm	in	mm	in	mm	in	mm	in	mm	in
45°	7.9	0.31	6.4	0.25	5.3	0.21	4.8	0.19	5.8	0.23	7.1	0.28
60°	7.9	0.31	10.7	0.42	5.3	0.21	4.8	0.19	5.8	0.23	7.1	0.28
70°	7.9	0.31	10.7	0.42	5.3	0.21	4.8	0.19	5.8	0.23	7.1	0.28
90°	7.9	0.31	18.3	0.72	8.6	0.34	4.8	0.19	5.8	0.23	7.1	0.28

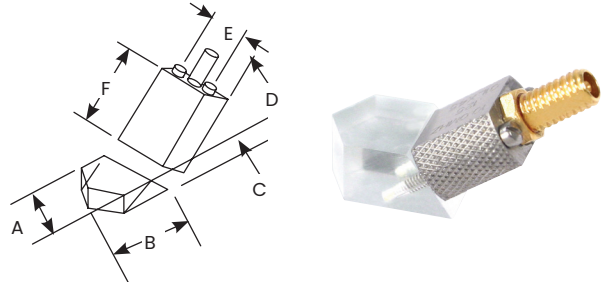

## Subminiature angle beam type SMSWS (Screw mount)

Freq. (MHz)	Element Ø		Order code		
	mm	in	Gamma series	Standard wedge	Accessories
2.25	3	0.125	113-212-585	118-340-120 45°	Cable BNC 118-140-047
				118-340-121 60°	
				118-340-122 70°	
				118-340-123 90°	
5.0	3	0.125	113-214-585	118-340-120 45°	Wedge couplant 118-300-740
				118-340-121 60°	
				118-340-122 70°	
				118-340-123 90°	
10.0	3	0.125	113-216-585	118-340-120 45°	
				118-340-121 60°	
				118-340-122 70°	
				118-340-123 90°	

Note: Standard wedge angles are specified for carbon steel. Custom configurations are available by special order.

# Angle beam transducers, dual element



## Applications

- VS shear wave type
  - Detection of small, near surface flaws
  - Thin-walled tubes and containers
  - Rings
- VRY and VSY longitudinal wave types
  - Coarse grain weld inspection
  - Attenuative materials
  - Austenitic welds
  - “Creeping wave” applications with 70° models

## Features and Benefits

- Excellent near surface resolution
- Reduce noise caused by scattering
- Durable, ergonomically-designed die cast housing
- Types VS and VSY have side mounted Microdot connectors
- Type VRY has Lemo 00 connectors

# Angle beam transducers, dual element

## Types VS, VRY and VSY

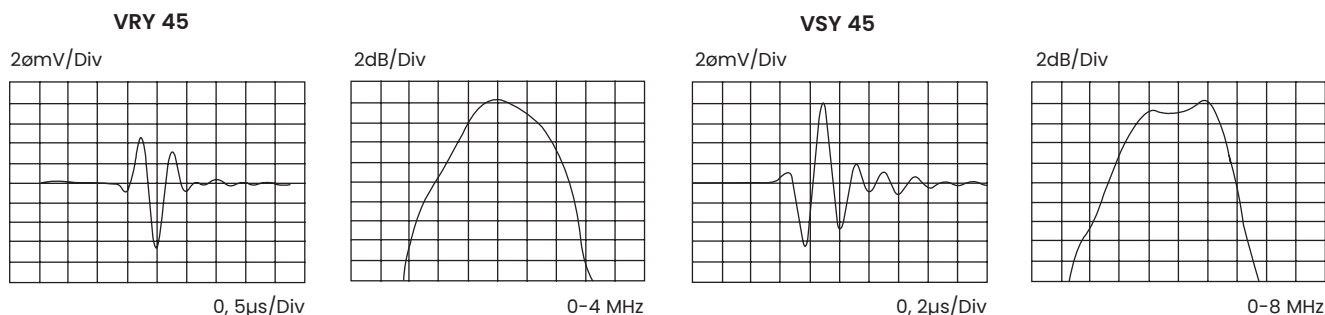

Typical waveform and frequency spectrum

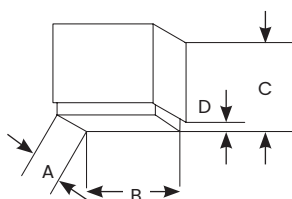

Case type	A		B		C		D	
	mm	in	mm	in	mm	in	mm	in
Type 30	14	0.55	24	0.94	22	0.87	2	0.08
Type 31	29	1.14	53.5	2.1	45	1.77	5	0.20
Type 32	15	0.59	30	1.8	27	1.06		

Type	Order code	a x b		f (MHz)	β (Steel)	F		Notes	Sketch
		mm	in			mm	in		
VS 45	0057660	3.5 x 10	0.14 x 0.39	4	45	10	0.4	ISO 22232-2 compliant	Type 30
VS 45-ISO	0500194	3.5 x 10	0.14 x 0.39	4	45	10	0.4		
VS 60	0057661	3.5 x 10	0.14 x 0.39	4	60	10	0.4		
VS 60-ISO	0500195	3.5 x 10	0.14 x 0.39	4	60	10	0.4		
VS 70	0057662	3.5 x 10	0.14 x 0.39	4	70	10	0.4		
VS 70-ISO	0500196	3.5 x 10	0.14 x 0.39	4	70	10	0.4	ISO 22232-2 compliant	
VRY 45	0057663	10 x 22	0.39 x 0.87	1.8	45	40	1.6	VRY and VSY angles are longitudinal (compression) wave suitable for testing coarse grain materials.	Type 31
VRY 60	0057664	10 x 22	0.39 x 0.87	1.8	60	35	1.4		
VRY 70	0057665	10 x 22	0.39 x 0.87	1.8	70	35	1.4		
VSY 45-2	0067154	5 x 10	0.20 x 0.39	2	45	16	0.6	70° models suitable for creeping wave excitation in mild steel.	Type 32
VSY 60-2	0067155	5 x 10	0.20 x 0.40	2	60	16	0.6		
VSY 70-2	0067156	5 x 10	0.20 x 0.41	2	70	16	0.6		
VSY 45-4	0054577	5 x 10	0.20 x 0.42	4	45	20	0.8		
VSY 60-4	0054578	5 x 10	0.20 x 0.43	4	60	20	0.8		
VSY 70-4	0054579	5 x 10	0.20 x 0.44	4	70	20	0.8		

Custom configurations are available by special order.

For explanations to the table data, refer to selection criteria on pages 5 through 7.

## Accessories

Description	Type	Remark
Cable	SEKM2 (0053001)	for VS
	SEKL2 (0050710)	for VRY
	SEKN2 (0053775)	for VSY



# Immersion transducers



## Applications

- Parts with irregular or complex geometry, such as gears and valves
- Automated or mechanized scanning
- Applications requiring very high near surface resolution or detection of very small flaws
- Scanning pipes, tubes and tanks
- Plates, billets and bars
- Disks, axles and shafts

## Features and benefits

- Acoustically matched for best efficiency in water
- Can be focused to a point (spherical) or to a line (cylindrical) for improved resolution, sensitivity and signal-to-noise ratio (refer to Selection Criteria on pages 5-7)
- European models have fixed cable with LEMO-1 connector.
- North American models have waterproof UHF connector, except IPS type, which has non-waterproof Microdot.

## Minimum and maximum standard focal lengths (Longer or shorter focal lengths may be available by special order)

Element diameter: mm (in)

Frequency (MHz)	mm	in	mm	in	mm	in	mm	in	mm	in	mm	in	mm	in	mm	in	
	25.4	1.0	20.0	0.79	19.1	0.75	12.7	0.5	10.0	0.39	9.5	0.375	6.4	0.25	5.0	0.2	
1.0	N	109	4.3	67	2.7	61	2.4	28	1.1								
	Min	50	2	40	1.5	40	1.5	25	1								
	Max	75	3	50	2	50	2	25	1								
2.0	N			135	5.3					34	1.3						
	Min			40	1.5					20	0.8						
	Max			100	4					25	1						
2.25	N	245	9.6			138	5.4	61	2.4			34	1.4	16	0.6		
	Min	50	2			40	1.5	25	1			20	0.8	13	0.5		
	Max	150	6			100	4	50	2			25	1	13	0.5		
3.5	N	381	15			215	8.4	94	3.7			53	2.1	24	0.9		
	Min	50	2			40	1.5	25	1			20	0.8	13	0.5		
	Max	200	8			150	6	60	2.5			40	1.5	17	0.7		
4.0	N			270	10.7					67	2.6						
	Min			40	1.5					20	0.8						
	Max			200	8					50	2						
5.0	N	544	21.4	337	13.4	307	12.0	137	5.4	84	3.3	76	3.0	35	1.3	21	0.9
	Min	50	2	40	1.5	40	1.5	25	1	20	0.8	20	0.8	13	0.5	10	0.4
	Max	200	8	200	8	200	8	100	4	60	2.4	50	2	25	1.0	15	0.6
10.0	N					615	24.1	272	10.7			152	6.0	69	2.7	42	1.7
	Min					40	1.5	25	1			20	0.8	13	0.5	10	0.4
	Max					200	8	150	6			100	4	50	2	30	1.2
15.0	N							406	16			228	9.0	104	4.0		
	Min							25				20	0.8	13	0.5		
	Max							150	6			150	6	60	2.5		

### Notes:

N = Near field length in water

Min = Minimum recommended focal length in water

Max = Maximum recommended focal length in water

Distances in steel are approximately 1/4 the distances given for water. Longer or shorter focal lengths may be available by special order.

# Immersion transducers—European standards

## Types Z, H and L

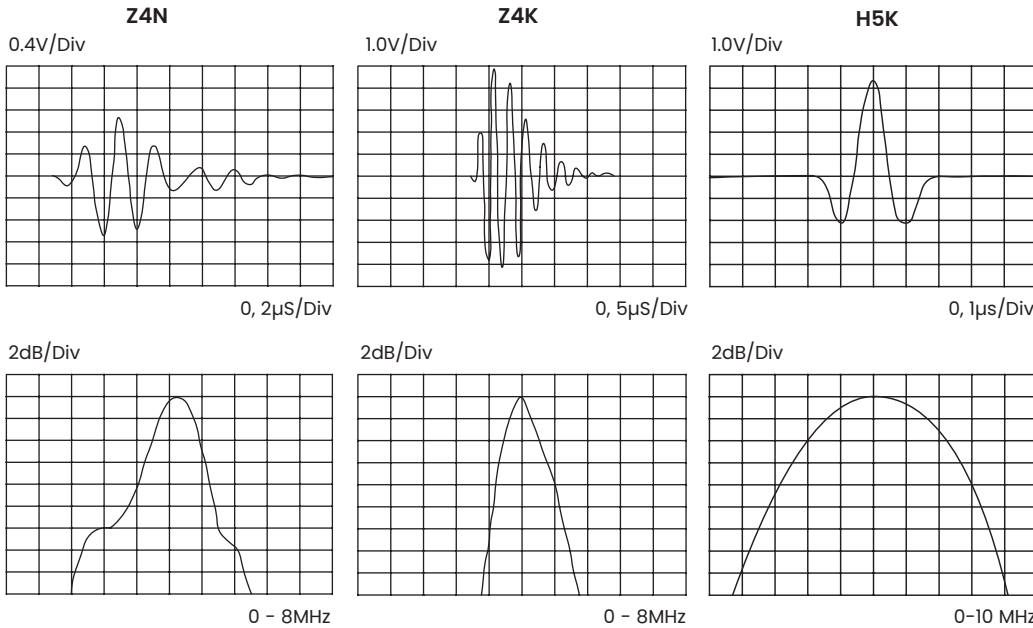

Typical waveform and frequency spectrum



Z..N, H..N and L..N



Z..K, H..K and L..K



Z..M, H..M and L..M

Type	Order code	D	f	N	Notes	Sketch	
		mm	in	(MHz)	mm	in	
Z 1 N	0053317	20	0.79	1	64	2.5	Type 33
Z 2 N	0053318	20	0.79	2	127	5.0	
Z 4 N	0053319	20	0.79	4	254	10.0	
Z 5 N	0054705	20	0.79	5	318	12.5	
Z 2 K	0053341	10	0.39	2	32	1.3	
Z 4 K	0053342	10	0.39	4	64	2.5	
Z 5 K	0053732	10	0.39	5	80	3.1	
Z 10 K	0054704	10	0.39	10	160	6.3	
Z 5 M	0055468	5	0.20	5	20	0.8	Type 35
Z 10 M	0053367	5	0.20	10	40	1.6	
Z 15 M	0055576	5	0.20	15	60	2.4	
H 1 N	0053042	20	0.79	1	64	2.5	Type 33
H 2 N	0053043	20	0.79	2	127	5.0	
H 2 K	0053300	10	0.39	2	32	1.3	Type 34
H 5 K	0053032	10	0.39	5	80	3.1	
H 10 K	0055818	10	0.39	10	160	6.3	
H 5 M	0053258	5	0.20	5	20	0.8	Type 35
H 10 M	0053041	5	0.20	10	40	1.6	
L 1 N	0053133	20	0.79	1	63	2.5	Type 33
L 2 N	0053134	20	0.79	2	127	5.0	
L 2 K	0053137	10	0.39	2	32	1.3	Type 34
L 5 K	0053139	10	0.39	5	80	3.1	
L 5 M	0053143	5	0.20	5	20	0.8	Type 35

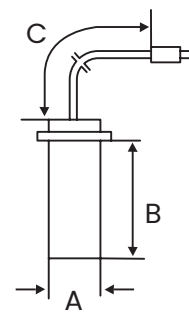

Case type	A		B		C	
	mm	in	mm	in	m	feet
Type 33	24	0.94	60	2.36	2.5	8.2
Type 34	13	0.51	60	2.36	2.5	8.2
Type 35	9.5	0.37	25	0.98	1.5	3.9

Also available with spherical (point) and cylindrical (line) focusing. Specify focal length. For available focal lengths, refer to the table at beginning of the Immersion Transducers section.

Custom configurations are available by special order.

For explanations to the table data, refer to selection criteria on pages 5 through 7.

# Immersion transducers— North American standards

## Types ISS and IS

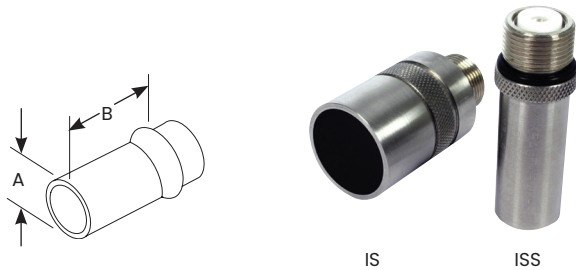

Element Ø		A		B	
mm	in	mm	in	mm	in
6	0.25	16	0.63	39.4	1.55
10	0.375	16	0.63	39.4	1.55
13	0.50	16	0.63	39.4	1.55
19	0.75	25.4	1.00	45.0	1.77
25	1.0	31.8	1.25	46.2	1.82

## Immersion transducers—types ISS and IS

Freq. (MHz)	Element Ø		Order code				Freq. (MHz)	Element Ø		Order code			
	mm	in	*Focus	Alpha series	Gamma series	Benchmark series		mm	in	*Focus	Alpha series	Gamma series	Benchmark series
1.0	19	0.750	S		113-251-360		5.0	6	0.250	S	113-124-280	113-224-280	
			C		113-251-370					C	113-124-290	113-224-290	
			N		113-251-380					N	113-124-300	113-224-300	113-824-300
	25	1.00	S		113-261-360	113-861-360		10	0.375	S	113-134-280	113-234-280	113-834-280
			C		113-261-370	113-861-370				C	113-134-290	113-234-290	113-834-290
			N		113-261-380	113-861-380				N	113-134-300	113-234-300	113-834-300
2.25	6	0.250	S		113-222-280		10.0	13	0.500	S	113-144-280	113-244-280	113-844-280
			C		113-222-290					C	113-144-290	113-244-290	113-844-290
			N	113-122-300	113-222-300	113-822-300				N	113-144-300	113-244-300	113-844-300
	10	0.375	S	113-132-280	113-232-280			19	0.750	S	113-154-360	113-254-360	113-854-360
			C	113-132-290	113-232-290					C	113-154-370	113-254-370	113-854-370
			N	113-132-300	113-232-300	113-832-300				N	113-154-380	113-254-380	113-854-380
13	0.500	S	113-142-280	113-242-280	113-842-280	25	1.00	S	113-164-360	113-264-360	113-864-360		
		C	113-142-290	113-242-290	113-842-290			C	113-164-370	113-264-370	113-864-370		
		N	113-142-300	113-242-300	113-842-300			N	113-164-380	113-264-380	113-864-380		
3.5	19	0.750	S	113-152-360	113-252-360	113-852-360	15.0	6	0.250	S	113-126-280	113-226-280	
			C	113-152-370	113-252-370	113-852-370				C	113-126-290	113-226-290	
			N	113-152-380	113-252-380	113-852-380				N	113-126-300	113-226-300	
	25	1.00	S	113-162-360	113-262-360	113-862-360		10	0.375	S	113-136-280	113-236-280	
			C	113-162-370	113-262-370	113-862-370				C	113-136-290	113-236-290	
			N	113-162-380	113-262-380	113-862-380				N	113-136-300	113-236-300	
13	0.500	S	113-143-280	113-243-280	113-843-280	13	0.500	S	113-146-280	113-246-280			
		C	113-143-290	113-243-290	113-843-290			C	113-146-290	113-246-290			
		N	113-143-300	113-243-300	113-843-300			N	113-146-300	113-246-300			
19	0.750	S	113-153-360	113-253-360	113-853-360	19	0.750	S	113-156-360	113-256-360			
		C	113-153-370	113-253-370	113-853-370			C	113-156-370	113-256-370			
		N	113-153-380	113-253-380	113-853-380			N	113-156-380	113-256-380			
25	1.00	S	113-163-360	113-263-360	113-863-360	6	0.250	S	113-127-280				
		C	113-163-370	113-263-370	113-863-370			C	113-127-290				
		N	113-163-380	113-263-380	113-863-380			N	113-127-300				
Note: Waterproof cables are in the accessories section.							6	0.250	1.5 in s	113-127-302 (TTC-100)			
									S	113-137-280			
									C	113-137-290			
									N	113-137-300			
									S	113-147-280			
									C	113-147-290			
13	0.500	N	113-147-300										

\* Focus: S = Spherical, C = Cylindrical, N = Non-focus. Focal length must be specified. For available focal lengths, refer to the table at the beginning of the Immersion Transducers section. Custom configurations are available by special order.

# Immersion transducers— North American standards

## Type IPS

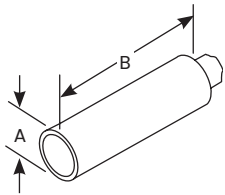

Element Ø		A		B	
mm	in	mm	in	mm	in
6	.250	9.7	0.38	36.8	1.45

## Immersion transducers—type IPS

Freq. (MHz)	Element Ø		Order code				Freq. (MHz)	Element Ø		Order code			
	mm	in	*Focus	Alpha series	Gamma series	Accessories		mm	in	*Focus	Alpha series	Gamma series	Accessories
2.25	6	0.25	N	113-122-340	113-222-340	Cable BNC 118-140-012 Non-waterproof	10.0	6	0.25	S	113-126-320	113-226-320	Cable BNC 118-140-012 Non-waterproof
										C	113-126-330	113-226-330	
										N	113-126-340	113-226-340	
5.0	6	0.25	S	113-124-320	113-224-320	15.0	6	0.25	S	113-127-320			
			C	113-124-330	113-224-330				C	113-127-330			
			N	113-124-340	113-224-340				N	113-127-340			

\* Focus: S = Spherical, C = Cylindrical, N = Non-focus. Focal length must be specified. For available focal lengths, refer to the table at the beginning of the Immersion Transducers section. Custom configurations are available by special order.

## Type IR

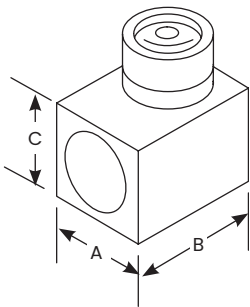

Element Ø		A		B		C	
mm	in	mm	in	mm	in	mm	in
6	0.250	19.1	0.75	23.9	0.94	19.1	0.75
10	0.375	19.1	0.75	23.9	0.94	19.1	0.75
13	0.500	19.1	0.75	23.9	0.94	19.1	0.75

## Immersion transducers—type IR

Freq. (MHz)	Element Ø		Order code				Freq. (MHz)	Element Ø		Order code				
	mm	in	*Focus	Alpha series	Gamma series	Accessories		mm	in	*Focus	Alpha series	Gamma series	Accessories	
2.25	6	0.25	N	113-122-420	113-222-420		5.0	6	0.25	S	113-124-400	113-224-400		
										C	113-124-410	113-224-410		
										N	113-124-420	113-224-420		
	10	0.375	S	113-132-400	113-232-400			10	0.375	S	113-134-400	113-234-400		
											C	113-134-410		113-234-410
											N	113-134-420		113-234-420
	13	0.50	S	113-142-400	113-242-400			13	0.50	S	113-144-400	113-244-400		
											C	113-144-410		113-244-410
											N	113-144-420		113-244-420

\* Focus: S = Spherical, C = Cylindrical, N = Non-focus. Focal length must be specified. For available focal lengths, refer to the table at the beginning of the Immersion Transducers section. Waterproof cables can be found in the Transducers Accessories Section. Custom configurations are available by special order.

# Transducers for specific applications

Baker Hughes Inspection Technologies' Application Centers provide a broad spectrum of services to users of nondestructive testing applications. Our mission is to bring together worldwide knowledge and experience across multiple industries and modalities to help customers quickly solve their inspection application problems.

With an unsurpassed track record, our highly skilled engineers, technicians and specialists are a key asset for our customers. Their experience is broad, encompassing many NDT modalities and many industry segments—from the development of a radiographic solution to inspect aerospace

parts on the manufacturing floor to the design of customized ultrasound transducers or eddy current probes for field inspection in the power, oil, gas and automotive industries.

New materials, manufacturing processes, and joining technologies often require customized ultrasonic transducers and accessories, designed specifically for the particular application. We offer a wide range of special application transducers, some of which are shown on these pages. Our special transducer teams are ready to address new application problems quickly and effectively.

## Special application transducers

### Roller (Wheel) transducers

Ultrasonic roller transducers and systems for the inspection of overlapped and butt laser welds or brazed joints and welds on tailored blanks with dry coupling.



### Low frequency transducers

Ultrasonic transducers for the inspection of coarse materials such as concrete, refractory bricks, stones, and wood.



### Axle transducers

Ultrasonic transducers for the inspection of railway axles and wheel sets.

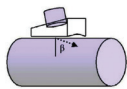

### Transducer holders

Ultrasonic transducer holders for special fixtures for the inspection of gas bottles and tubes.



### Transverse (Shear) wave straight beam transducers

Normal incidence transverse wave transducers typically used for characterization of materials.



### Spot weld transducers

Ultrasonic transducers with a flexible acoustic interface for inspection of resistance welded spot welds on automotive bodies.



### MIG/MAG transducers

Ultrasonic transducers for the inspection of MIG and MAG welds using the ultrasonic transmission technique.



### Tube testing transducers

Ultrasonic transducers for the inspection of tubes and hollow railway axles and wheel sets.



### High temperature transducers

Ultrasonic transducers for inspection at higher temperatures with heat resistant delays.



### High frequency immersion transducers

Very high resolution immersion transducers, 25 MHz to 50 MHz.



### RL transducers

Refracted longitudinal wave angle beam transducers, single and dual element, for inspection of coarse grain materials such as austenitic steel pipe welds.



### Boreside arrays

Multi-element ultrasonic transducers, with water feed, for the inspection of tubing from the ID.



### ZIP probes

"Zero Interface" delay line transducers for manual inspection of composite materials.

# Phased array transducers

Baker Hughes Inspection Technologies manufactures a wide variety of phased array transducers for use with Mentor UT and other instruments. Phased array transducers with the Dialog feature recognize physical connection and automatically download transducer information to Mentor UT.

## Small and mid-sized phased arrays for general angle and straight beam applications

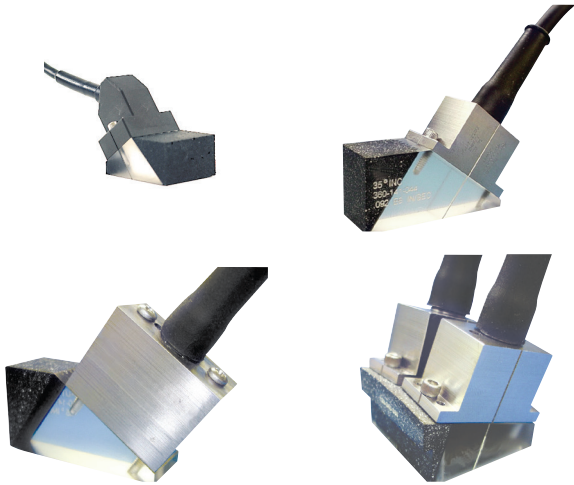

### Applications

- Power: General weld inspection, austenitic welds, pressure vessels and piping, turbine blades, rotors
- Oil and Gas: Pipeline girth welds, tanks, general weld inspection
- Aerospace: Weld inspection, landing gear
- Automotive: Axles, shafts, spindles, brake discs, wheels
- General: Welds, forgings, castings, tubular goods, bridges and structures

### Features and benefits

- Electronic control of beam angle, focus, and scanning index
- Eliminate multiple inspections with fixed angle and fixed focus probes.
- Inspect hard to access areas from a single contact point.
- Replaceable angle beam wedges and 0° delay lines, flat or curved
- Probes with internal wedges and delay lines are also available.

### Typical specifications (Others available upon request)

Frequency (MHz)	Element count	Pitch mm (in)	Elevation mm (in)
1.0	16, 32, 64, 128	1 to 3 (0.04 to 0.12)	10 to 25 (0.4 to 1.0)
1.5	16, 32, 64, 128	0.75 to 3 (0.03 to 0.12)	10 to 25 (0.4 to 1.0)
2.25	16, 32, 64, 128	0.5 to 2 (0.02 to 0.08)	6 to 20 (0.25 to 0.8)
3.5	16, 32, 64, 128	0.5 to 2 (0.02 to 0.08)	6 to 20 (0.25 to 0.8)
5.0	16, 32, 64, 128	0.25 to 1.5 (0.01 to 0.06)	6 to 20 (0.25 to 0.8)
7.5	16, 32, 64, 128	0.25 to 1 (0.01 to 0.04)	6 to 16 (0.25 to 0.63)

## Phased array for scanning and wide area coverage, immersion or delay line

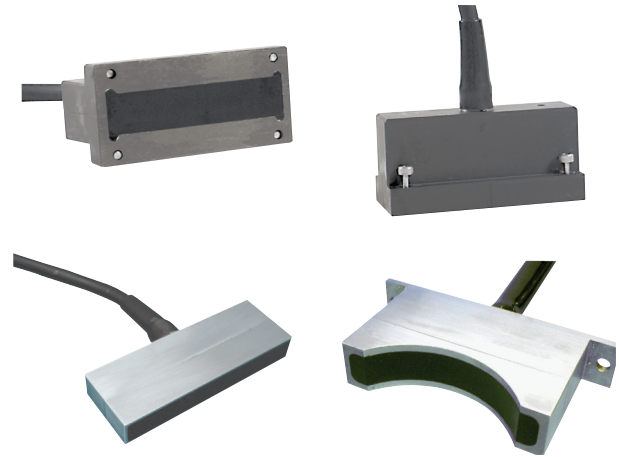

### Applications

- Power Generation: Pressure vessels, piping
- Oil and Gas: Piping, tanks
- Aerospace: Composite delamination and disbond, weld inspection, landing gear
- Transportation: Composite delamination and disbond, plates
- General: Large area scanning, plate, bar, tubular goods, in-line thickness measurement

### Features and benefits

- Electronic control of beam angle, focus, and scanning index
- Reduce set-up and scan times.
- Increase sensitivity and signal-to-noise ratio with electronic focusing.
- Reduce or eliminate mechanical and manual manipulation.
- Use immersion method or with replaceable delay line.

### Typical specifications (Others available upon request)

Frequency (MHz)	Element Count	Pitch/mm (in)	Elevation/mm (in)
1.0	32, 64, 128	1 to 3 (0.04 to 0.12)	10 to 25 (0.4 to 1.0)
1.5	32, 64, 128	0.75 to 3 (0.03 to 0.12)	10 to 25 (0.4 to 1.0)
2.25	32, 64, 128	0.5 to 2 (0.02 to 0.08)	6 to 20 (0.25 to 0.8)
3.5	32, 64, 128	0.5 to 2 (0.02 to 0.08)	6 to 20 (0.25 to 0.8)
5.0	32, 64, 128	0.25 to 1.5 (0.01 to 0.06)	6 to 20 (0.25 to 0.8)
7.5	32, 64, 128	0.25 to 1 (0.01 to 0.04)	6 to 16 (0.25 to 0.63)
10.0	32, 64, 128	0.25 to 1 (0.01 to 0.04)	6 to 13 (0.25 to 0.5)

# Transducer accessories

## Cables and adapters

### Plug type

Cable type	Order code	Length m (ft)	Impedance (ohms)	Transducer	Instrument
CL 331	0058160	2 (6.5)	50	Microdot	LEMO-00
MPKLL 2	0058791	2 (6.5)	50	LEMO-00	LEMO-00
MPKL 2	0050486	2 (6.5)	50	LEMO-00	LEMO-1
MPKM 2	0052999	2 (6.5)	50	Microdot	LEMO-1
PKP 2	0066709	2 (6.5)	75	LEMO-03 Waterproof	LEMO-1
PKI 2	0057694	2 (6.5)	75	UHF Waterproof	LEMO-1
PKLL 2	0050326	2 (6.5)	75	LEMO-1	LEMO-1
PKTL 2	0052642	2 (6.5)	50	LEMO-1 Waterproof	LEMO-1
SEKG 2	0053887	2 (6.5)	50	LEMO-00 Dual Plug	2x LEMO-1
SEKL 2	0050710	2 (6.5)	50	2x LEMO-00	2x LEMO-1
SEKM 2	0053001	2 (6.5)	50	2x Microdot	2x LEMO-1
SEKN 2	0053775	2 (6.5)	50	1x Microdot 1x Microdot, Large	2x LEMO-1
VKLL 5	0050484	5 (16.4)	75	LEMO-1 Coupling	LEMO-1
MD-BNC	118-140-012	1.8 (6)	50	Microdot	BNC
MD-BNC 12	118-140-011	3.6 (12)	50	Microdot	BNC
MMD-BNC	118-140-047	1.8 (6)	50	MMD	BNC
MD/RA-BNC	118-140-033	1.8 (6)	50	Right Angle Microdot	BNC
BNC-BNC	118-140-016	1.8 (6)	50	BNC	BNC
BNC-BNC 12	118-140-021	3.6 (12)	50	BNC	BNC
UHF-BNC	118-140-027	1.8 (6)	50	UHF Non-waterproof	BNC
L1-BNC	118-140-018	1.8 (6)	50	LEMO-1	BNC
UHF/WP-BNC	118-140-013	1.8 (6)	75	UHF Waterproof	BNC
Dual MMD-BNC	118-140-014	1.8 (6)	50	2x MMD	2x BNC
Dual MD-BNC	118-140-024	1.8 (6)	50	2x Microdot	2x BNC

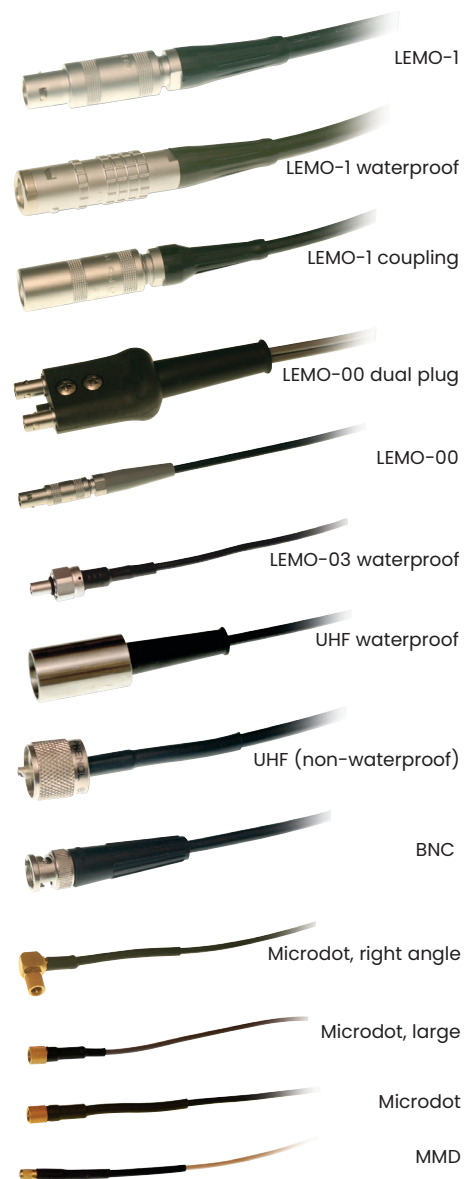

Adaptor type	Order code	Transducer	Instrument
PKLB1	0053013	BNC Socket	LEMO-1 Plug
PKBL1	0053014	LEMO-1 Socket	BNC Plug
STUHF-RA (Right angle)	118-560-032	UHF Plug Waterproof	UHF Socket Waterproof
DM-BNC dual	118-560-045	D-Meter Plug	2x BNC



# Couplants

## General purpose couplants

Couplant type	Container size	Description	Order Code	Features
ZG-F	2.5 kg(5.5 lb)	General purpose	0050469	<ul style="list-style-type: none"><li>• Thixotropic paste</li><li>• Non-drip, washable, non-corrosive</li><li>• Temperature range -4°F to 212°F (-20°C to 100°C)</li><li>• Safety data sheet per 91/155/EEC</li></ul>
	5 bottles 250 ml (8.5 fl oz.)	General purpose	0054558	
ZGT	100 g Tube (3.5 oz.)	Multigrade couplant	0050472	<ul style="list-style-type: none"><li>• Medium viscosity paste</li><li>• Water resistant, non-corrosive</li><li>• Temperature range -22°F to 480°F (-30°C to 250°C)</li><li>• Safety data sheet per 91/155/EEC</li></ul>

## Specialty couplants

Couplant type	Container size	Description	Order Code	Features
ZGM	100 g Tube (3.5 oz.)	High temperature coupling paste	0056567	<ul style="list-style-type: none"><li>• High viscosity paste</li><li>• Solid filler melts at elevated temperature</li><li>• Specially formulated for thickness measurement on hot parts</li><li>• Temperature range 390°F to 1100°F (200°C to 600°C)</li></ul>

# Calibration blocks

Calibration blocks provide known targets that produce echo indications that are used for instrument setup, transducer evaluation, and reference for evaluating flaw size.

## Calibration blocks—European standards

Block type (Steel)	Order code	Description
K1 ISO 12223	0059108	<ul style="list-style-type: none"> <li>Large angle beam calibration block, 100 mm radius</li> <li>Calibrate range with an angle beam transducer</li> <li>Measure beam index point and refracted angle</li> </ul>
K2 ISO 27963/ISO 7963	0050434	<ul style="list-style-type: none"> <li>Small angle beam calibration block, 25 and 50 mm radii</li> <li>Calibrate range with an angle beam transducer</li> <li>Measure beam index point and refracted angle</li> </ul>
VW	0050441	<ul style="list-style-type: none"> <li>Step block for calibrating thickness range</li> <li>Eight .039 in (1 mm) steps, .039 in (1 mm) through .315 in (8 mm)</li> </ul>
N30	0058474	<ul style="list-style-type: none"> <li>Ultrasonic reference standard</li> <li>Connect directly to flaw detector</li> <li>Produces multiple echoes at precise intervals in steel</li> <li>Check instrument gain over long time periods</li> </ul>

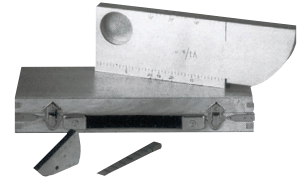

## Calibration blocks—North American standards

Block type (Steel)	Order code	Description
IIW Type 1	118-540-270	<ul style="list-style-type: none"> <li>Large angle beam calibration block</li> <li>4.0 in (101.6 mm) radius for angle beam range calibration</li> <li>Measure beam index point and refracted angle</li> <li>Also used to check resolution and sensitivity</li> </ul>
IIW Type 2	118-540-280	<ul style="list-style-type: none"> <li>Same as IIW Type 1 with 2 in (50.8 mm) and 4 in (101.6 mm) radii for range calibration</li> <li>Side drilled holes also added for resolution check</li> </ul>
DSC	118-540-300	<ul style="list-style-type: none"> <li>Small block for angle beam distance and sensitivity calibration</li> <li>1.0 in (25.4 mm) radius opposite a 3.0 in (76.2 mm) radius</li> <li>0.375 in (9.5 mm) slot in the 3.0 in (76.2 mm) radius</li> <li>Also used to check beam index point and refracted angle</li> </ul>
Angle Beam, Miniature	118-540-260	<ul style="list-style-type: none"> <li>Substitute for DSC block</li> <li>1.0 in (25.4 mm) radius opposite a 2.0 in (50.8 mm) radius</li> <li>Side drilled hole to check beam index point and refracted angle</li> </ul>
AWS Resolution	118-540-350	<ul style="list-style-type: none"> <li>Evaluate angle beam transducer resolution capability</li> <li>Three sets of side drilled holes for 45°, 60° and 70° angles</li> <li>Three 0.062 in (1.6 mm) diameter holes in each set of holes</li> </ul>
NAVSHIPS Test Block	118-540-370	<ul style="list-style-type: none"> <li>For NAVSHIPS specification 0900-006-3010, Section 6</li> <li>Distance amplitude correction, sensitivity, and flaw depth</li> </ul>
4-Step Block	118-540-320	<ul style="list-style-type: none"> <li>Step block for calibrating thickness range</li> <li>Steps .250, .500, .750, 1.00 in (6.35, 12.70, 19.05, 25.40 mm)</li> </ul>
5-Step Block	118-540-310	<ul style="list-style-type: none"> <li>Step block for calibrating thickness range</li> <li>Steps .100, .200, .300, .400, .500 in (2.54, 5.08, 7.62, 10.06, 12.70 mm)</li> </ul>

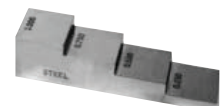
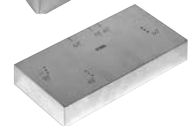
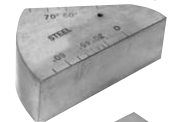

# Transducer kits

Our transducer kits combine the most commonly used transducers and accessories necessary for general, and some specific, ultrasonic testing applications. Each kit includes a hard shell carrying case for easy access, convenient storage and transportation.

## Transducer kits—European standards

Type	Order code	Description	Probe contents
PKS 1	0057281	Coarse Grain set	K0,5S; K1SM; WRY45; WRY70; WB45-1; WSY45-4, WSY70-4
PKS 2	0057282	Aircraft set	B4S; K4G; G5KB; MSEB4; K5K; CLF4; SEB10KF3; 2x MWB45-4; MWB70-4; MWB90-4
PKS 3	0057283	Steel set	B4S; SEB2; G5KB; MSEB4; MB4F; WK45-2; WK70-2; 2x MWB45-4; MWB70-4
PKS 4	0057284	Welding set	MB4S; SEB4; WB45-2; WB70-2; MWB45-2; 2x MWB45-4; MWB60-4; 2x MWB70-4
PKS 5	0057285	Casting set	B2S; SEB2; K1S; MB2S; SEB4KF8; G5KB; WB45-1; WB70-1; MWB45-2
PKS 6	0057286	Forging set	B4S; B2S; SEB2; MB4S; K2N; SEB4KF8; MB4F; WB45-2; MWB45-4; MWB70-4

## Transducer kits—North American standards

### Basic contact kit

#### Product order code 118-450-020

Wide assortment for weld inspection, lamination detection, corrosion/erosion and thin gauge materials.

Qty.	Product code	Description
1	113-292-603	2.25 MHz, 0.63 in x 0.63 in AWS style, single element
1	113-242-591	2.25 MHz, .5 in MSW-QC Style, BMC single element angle beam probe
1	113-262-043	2.25 MHz, 1 in CR style, single element contact probe
1	113-544-000	5 MHz, 0.5 in CA211A style, single element contact probe
1	113-252-240	2.25 MHz, 0.75 in PFCR style, single element membrane probe

Qty.	Product code	Description
1	113-527-660	15 MHz, 0.25 in ALPHA 2 DFR style, single element delay line probe
1	113-292-751	2.25 MHz, 0.5 in x 0.5 in DU-F style, dual element contact probe
1	113-224-681	5 MHz, 0.25 in RC style, dual element contact probe
1	118-140-012	BNC-MD coaxial cable
1	118-140-016	BNC-BNC coaxial cable
1	118-140-024	BNC-MD dual coaxial cable
1	118-140-088	BNC-RC dual coaxial cable

Qty.	Product code	Description
1	118-440-050	Delay lines for 113-527-660 (10 pcs.)
1	118-450-140	Protective membrane kit for 113-252-240 PFCR probe.
1	118-340-104, 106	45° and 70° Lucite wedge
1	118-340-211, 212, 213	45°, 60° and 70° Lucite wedge
1	118-540-198	Calibration block 0.1 in–0.5 in
1	118-800-025	Diced foam carrying case

### Basic AWS weld inspection kit order code 118-450-500

Transducers and accessories for testing weldments to specification AWS D1.1.

Qty.	Product code	Description
1	113-292-603	2.25 MHz, 0.63 in x 0.63 in AWS style, single element angle beam probe
1	113-292-601	2.25 MHz, 0.63 in x 0.75 in AWS style, single element angle beam probe
1	113-292-604	2.25 MHz, 0.75 in x 0.75 in AWS style, single element angle beam probe
1	113-262-043	2.25 MHz, .1 in dia. CR-RHP, L-wave contact probe
1	118-340-104	45° Lucite wedge
1	118-340-105	60° Lucite wedge
1	118-340-106	70° Lucite wedge
1	118-140-016	BNC-BNC coaxial cable
1	118-540-196	DSC reference standard
1	118-800-025	Diced foam carrying case

### Multi-purpose contact kit order code 118-450-510

Commonly used transducers for a variety of angle beam, lamination, corrosion, general flaw, and thickness testing.

Qty.	Product code	Description
1	113-544-000	5 MHz, 0.5 in dia. CA211A style, single element contact probe
1	113-262-043	2.25 MHz, 1 in dia. CR style, single element contact probe
1	113-527-660	15 MHz, 0.25 in Alpha 2 DFR style, delay line probe
1	113-224-700	5 MHz, 0.25 in dia. ADP style, dual element probe
1	113-244-591	5 MHz, 0.5 in dia. MSW-QC style, benchmark angle beam probe
2	118-340-211	45° Lucite wedge
2	118-340-212	60° Lucite wedge
2	118-340-213	70° Lucite wedge
2	118-140-016	BNC-BNC coaxial cable
2	118-140-012	BNC-MD coaxial cable
1	118-540-198	5 Step reference standard, 1 in–0.5 in
1	118-800-025	Diced foam carrying case

### Basic angle beam kit order code 118-450-030

Assortment for weld and other angle beam inspections.

Qty.	Product code	Description
1	113-294-642	5 MHz, 70° ABFP-SM, single element angle beam probe
1	113-216-585	10 MHz, 0.125 in SMSWS style, single element angle beam probe
1	113-294-600	5 MHz, 5 in x 1 in SWS style, single element angle beam probe
1	113-224-591	5 MHz, 0.25 in MSWQC style, benchmark angle beam probe
1	118-540-196	DSC reference standard
1	118-140-047	BNC-MMD coaxial cable
1	118-140-016	BNC-BNC coaxial cable
1	118-140-012	BNC-MD coaxial cable
1 ea.	118-340-120, 122	45° and 70° Lucite wedge
1 ea.	118-340-015, 017	45° and 70° Lucite wedge
1 ea.	118-340-201, 202, 203	45°, 60° and 70° Lucite wedge
1	118-800-025	Diced foam carrying case

# Transducer certification

## European standards

Each delivered probe is subjected to a very strict quality test that makes certain all probes of the same type identically evaluate flaws. The corresponding probe data sheet contains proof of the data reliability. We store the data of every numbered probe for a number of years, enabling probe certificates (PZ) to also be produced at a later date.

Certificate	Order code	Description
PZ-E	0057682	Waveform and frequency spectrum for standard catalog flaw transducers, including amplitude, frequency, bandwidth, and pulse duration
PZ-EN	0059969	Detailed certificate of calibration according to standard EN 12668-2, "Non-destructive testing - Characterization and verification of ultrasonic examination equipment - Part 2: Probes", ratified by European Committee for Standardization (CEN)

## North American standards

Certificate	Order code	Description
Waveform/ Frequency	113-900-911	Waveform and frequency spectrum for standard catalog flaw transducers, including amplitude, frequency, bandwidth, and pulse duration
Beam Profile	113-900-913	Plot is made by moving the transducer across a ball or rod reflector in an immersion tank. The beam profile gives the relative intensity and width of the sound beam at a given distance from the transducer face.

# Tables and formulas

## dB vs. Amplitude ratio chart

dB	Ratio	dB	Ratio	dB	Ratio	dB	Ratio
0	1.00:1	5	1.78:1	11	3.55:1	17	7.08:1
.5	1.06:1	6	2.00:1	12	3.98:1	18	7.94:1
1	1.12:1	7	2.24:1	13	4.47:1	19	8.91:1
2	1.26:1	8	2.51:1	14	5.01:1	20	10.00:1
3	1.41:1	9	2.82:1	15	5.62:1	40	100.00:1
4	1.58:1	10	3.16:1	16	6.31:1	60	1000.00:1

## Near field length (N) in water

### Element diameter

Frequency (MHz)	Element diameter							
	mm 25.4	in 1.0	mm 19.1	in 0.75	mm 12.7	in 0.50	mm 6.3	in 0.25
1.0	109.2	4.3	61	2.4	27.2	1.07	6.8	0.27
2.25	243.8	9.6	137.1	5.4	61.0	2.4	15.3	0.60
5.0	543.5	21.4	304.8	12.0	137.1	5.4	33.0	1.3
10.0	1092.2	43	609.6	24	271.8	10.7	68.6	2.7

To find approx. length in steel, divide the above values by 4.

## Velocity and acoustic impedance of common materials

Material	Longitudinal velocity		Shear velocity		Acoustic impedance MRayl
	in/s x 10 <sup>6</sup>	km/s	in/s x 10 <sup>6</sup>	km/s	
Air	0.013	.33	-	-	.0004
Aluminum	0.25	6.3	0.12	3.1	17.0
Aluminum oxide	0.39	9.9	0.23	5.8	32.0
Beryllium	0.51	12.9	0.35	8.9	23.0
Boron carbide	0.43	11.0	-	-	26.4
Brass	0.17	4.3	0.08	2.0	36.7
Cadmium	0.11	2.8	0.059	1.5	24.0
Copper	0.18	4.7	0.089	2.3	41.6
Glass (Crown)	0.21	5.3	0.12	3.0	18.9
Glycerin	0.075	1.9	-	-	2.42
Gold	0.13	3.2	0.047	1.2	62.6
Ice	0.16	4.0	0.08	2.0	3.5
Inconel	0.22	5.7	0.12	3.0	47.2
Iron	0.23	5.9	0.13	3.2	45.4
Iron (Cast)	0.18	4.6	0.10	2.6	33.2
Lead	0.085	2.2	0.03	0.7	24.6
Magnesium	0.23	5.8	0.12	3.0	10.0
Mercury	0.057	1.4	-	-	19.6
Molybdenum	0.25	6.3	0.13	3.4	64.2
Monel	0.21	5.4	0.11	2.7	47.6
Neoprene	0.063	1.6	-	-	2.1

Material	Longitudinal velocity		Shear velocity		Acoustic impedance MRayl
	in/s x 10 <sup>6</sup>	km/s	in/s x 10 <sup>6</sup>	km/s	
Nickel	0.22	5.6	0.12	3.0	49.5
Nylon, 6-6	0.10	2.6	0.043	1.1	2.9
Oil (SAE 30)	0.067	1.7	-	-	1.5
Platinum	0.13	3.3	0.067	1.7	69.8
Plexiglass	0.11	2.7	0.043	1.1	3.1
Polythylene	0.07	1.9	0.02	0.5	1.7
Polystyrene	0.093	2.4	0.04	1.1	2.5
Polyurethane	0.070	1.9	-	-	1.9
Quartz	0.23	5.8	0.087	2.2	15.2
Rubber, butyl	0.07	1.8	-	-	2.0
Silver	0.14	3.6	0.06	1.6	38.0
Steel, mild	0.23	5.9	0.13	3.2	46.0
Steel, stainless	0.23	5.8	0.12	3.1	45.4
PTFE	0.06	1.4	-	-	3.0
Tin	0.13	3.3	0.07	1.7	24.2
Titanium	0.24	6.1	0.12	3.1	27.3
Tungsten	0.20	5.2	0.11	2.9	101.0
Uranium	0.13	3.4	0.08	2.0	63.0
Water	0.0584	1.48	-	-	1.48
Zinc	0.17	4.2	0.09	2.4	29.6

## Useful formulas

Near field length	$D^2F/4C$ or $D^2/4\lambda$
Beam spread	$\text{SIN}_\gamma C/DF \times 1.22$ or $1.22\lambda/D$
Snell's law	$\text{SIN}_\alpha / \text{SIN}_\beta = C_1/C_2$
Skip distance	$2T \times \text{TAN}_\beta$
V-Path	$2T/\text{COS}_\beta$
Surface distance (Projected)	$\text{S.P.} \times \text{SIN}_\beta$
Depth (1st Leg)	$\text{S.P.} \times \text{COS}_\beta$
Depth (2nd Leg)	$2T - (\text{S.P.} \times \text{COS}_\beta)$
Depth (3rd Leg)	$(\text{S.P.} \times \text{COS}_\beta) - 2T$
Wavelength	$C/F$
Frequency	$C/\lambda$
Acoustic impedance	$Z = C \times d$
% of Reflected sound pressure	$R_p = (Z_2 - Z_1)/(Z_2 + Z_1)$
Coefficient of transmission	$T_p = 2Z_2/(Z_2 + Z_1)$
Total beam width	$TBW = (\text{Depth} - N) (2\text{TAN}_\gamma) + T \times \text{Element diameter}$

Transit time	$TT = 2T/C$
Center frequency	$F_c = (F_1 + F_2)/2$
% Bandwidth	$(F_1 - F_2)/F_c \times 100\%$
Q factor	$F_c/(F_1 - F_2)$
Distance	Speed x time
RPM	Speed/circumference
Maximum scanning speed (x, y)	(Min. flaw length + EBW) x PRR
Maximum scanning speed (polar)	RPM x Diameter x Clock interval (ft per min.)
dB Difference	$20 \text{Log} (A1/A2)$
dB Ratio	$\text{Inv log dB}/20$
Water equivalent = (Steel)	$WE = F(\text{water}) \times (C(\text{water}))/C(\text{steel})$ (F = Focal length)
MAXR	$\text{SIN}^{-1} (ID/OD)$
Focal length	$R = F(n - 1)/n$
Cylinder offset technique	Offset (X) = Outside radius x SIN $\alpha$

### Symbol key

$\lambda$ = Wavelength
D = Probe diameter
F = Probe frequency
C = Acoustic velocity
d = Density
$\alpha$ = Incident angle
$\beta$ = Refracted angle
T = Part thickness
S.P. = Sound path
N = Near field
$\gamma$ = Divergence 1/2 angle

# Baker Hughes sensing and inspection technologies

Baker Hughes sensing and inspection technologies provides technology-driven inspection solutions that deliver productivity, quality and safety. We design, manufacture and service ultrasonic, remote visual, radiographic and eddy current equipment to inspect, monitor and test materials and equipment without disassembling, deforming or damaging them.

We offer specialized products and services that will help improve productivity in a wide range of industries including aerospace, power generation, oil and gas, automotive and metals.



**Ultrasonic**



**Eddy current**



**Radiography**



**Remote visual**



**Hardness testing**



**Metrology**



**Software**

# Solutions & services

## Application centers

### Help and available all around the world

We have 11 application centers strategically sited around the world which provide our customers with personalized problem solving and custom transducer designs for the toughest applications. We offer advice and assistance to many different industry segments.

- Highly skilled, experienced and dedicated team
- Covering a wide range of NDT disciplines
- Solving inspection application problems quickly
- Providing industry-specific expertise for unique problems
- Designing and manufacturing custom-made transducers for most applications

## Product services

### Maximizing uptime and maintaining optimum performance

We provide our customers with a wide range of product support which covers practically any eventuality from simple repair to training and software updates. A world-class standard of service and our financial stability means that you can count on us to be there when needed.

- Field service, repair and calibration
- Parts fulfilment services
- Training programs
- Technical phone support
- Remote monitoring and diagnostics
- Software and hardware upgrades
- Rental, lease and finance solutions

# Regional offices

## Europe

### Germany

Robert Bosch Strasse 3  
50354 Huerth  
+49 2233 6010

### United Kingdom

Fir Tree Lane  
Groby LE6 0FH  
+44 845 601 5771

### France

68, Chemin des Ormeaux  
Limonest 69760  
+33 47 217 9220

### Spain

San Maximo, 31, Planta 4A, Nave 6  
Madrid 28041  
+34 915 500 59 90

## America

### United States

721 Visions Drive  
Skaneateles, NY 13152  
+1 888 332 3848 (toll free)  
+1 315 554 2000 ext. 1

Customer Care  
+1 844 991 0494

### Brazil

Av. das Nacoes Unidas, 8501 1st floor  
São Paulo, SP 05425-070  
+55 3067 8166

## Asia

### China

5F, Building 1, No.1 Huatuo Road,  
Zhangjiang High-Tech Park,  
Shanghai 201203  
+86 800 915 9966 (toll-free)  
+86 (0) 21-3877 7888

Unit 1602, 16/F Sing Pao Building  
101 King's Road  
North Point  
Hong Kong  
+852 2877 0801

### Japan

7F Medie Corp Bldg. 8  
2-4-14 Kichijoji Honcho, Musashino-shi  
Tokyo 180-0004  
+81 442 67 7067

Waygate Technologies, a Baker Hughes Business has sales and service offices all over the world. Below are some of our locations.

Visit [www.waygate-tech.com](http://www.waygate-tech.com)

- Berchem, Belgium
- Alzenau, Germany
- Burford, United Kingdom
- Moscow, Russia
- Bucharest, Romania
- Prague, Czech Republic
- Stockholm, Sweden
- Milan, Italy
- East Perth, Australia
- Singapore
- Dubai, UAE
- Buenos Aires, Argentina
- Mexico City, Mexico
- Airdrie, Alberta, Canada
- Toronto, Ontario, Canada
- Montreal, Quebec, Canada